



Standard

Change-Makers, Inc.

P.O. Box 36550
Indianapolis, IN 46236-0550
3130 N. Mitthoeffer Road
Indianapolis, IN 46235-2400
1-800-968-6955
Phone: (317) 899-6966
Fax: (317) 899-6977

GUARDIAN XP

Card & Code Systems Installation Quick Guide

Part #8M00589 Rev. 3/2013

SITE PLANNING & INSTALLATION GUIDE - GXP CARD SYSTEMS, CODE SYSTEMS, AND

MISC OPTIONS

8M00589 Rev: 3-5-13

Use this guide to identify the Connections and Setup required to connect a GXP pay station to a POS, Card, Reporting, or Site Monitoring System.

- CONDUITS & CABLES..... 2
- “NETWORK SWITCH BOX” 3
- “NETWORKING GXP’S” 4
- “SitePRO” CARD & MONITORING SYSTEM.....5
- “WASHGEAR” CARD SYSTEM.....6
- “WASHCARD” CARD SYSTEM7
- “ONE CARD” CARD SYSTEM 8
- “QUICK PAY” CARD SYSTEM9
- “INTERCOM” CONNECTIONS.....10
- “FUEL DISPENSER” POS CONNECTIONS.....12
- “POS4000” CODE TERMINAL.....13
- “CODE COMMAND I” HARDWIRED.....15
- “CODE COMMAND II” HARDWIRED.....17
- “CODE COMMAND II “ENCRYPTED”19
- “CODE COMMAND II “INTERNET”21
- “EXPRESS WASH RFID SYSTEM”24

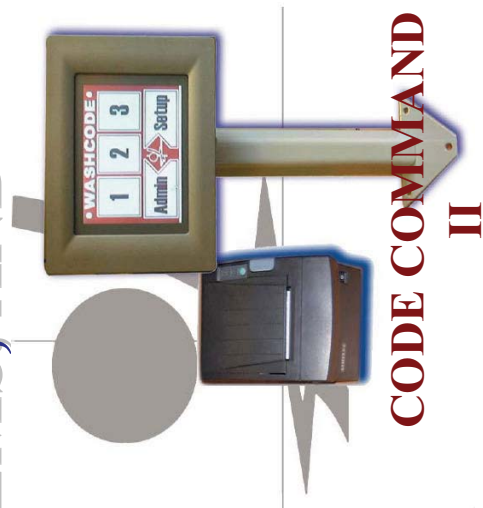

CODE COMMAND II



CODE COMMAND I

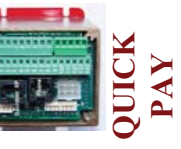

QUICK PAY



REMOTE CARWASH MANAGER



WASHGEAR



CONDUIT & CABLES

GENERAL SUGGESTIONS:

Cables – There are two types of cable commonly used: CAT5 and twisted pair shielded. Each has their advantages. Shielded Twisted Pair cable is ideal for RS485 communication and Intercom connections. This cable has two pairs of wires that are twisted (to reduce noise coupling from one lead to the other) and that are shielded. The shielding provides a protective barrier to prevent noise from radiating (coupling) from another cable that may be present in the same conduit. CAT5 cable includes multiple twisted pairs of wires, is less expensive than twisted pair shielded, and is solid strand. The solid strand (as opposed to multiple strands) makes this cable more susceptible to breaking if the wire is moved periodically for any reason. Although the CAT5 is less expensive it is more susceptible to surge and noise coupling because it is not typically shielded. The choice of wire is up to the installer. The integrity of the communication is based on the choice of wire to be used, the number and type of cable included in a single conduit, and the route for the conduit.

We recommend that all RS485 data lines be a twisted pair shielded cable, 18 gauge or greater (up to 14 ga.). RS485 data lines are typically used to hard-wire connect a Code Sales Terminal (POS4000, Code Command I or Code Command II). The cable required for an Intercom System connection should be specified in the Intercom Manual. If this information is not present we recommend we recommend using the same cable as is used for the RS485 data lines.

Conduits - Whenever possible it is always a good idea to separate the “data cables” from the “power cables” in different conduits. Separating these will improve data transmission reliability as well as prevent power surge coupling between power lines and data lines. Separating these two lines into different conduits is not always practical or feasible.

Terminations & Setup – For terminations & setup of all device connections within the GXP, see the associated page of this installation guide. For terminations, setup the device that Read the installation manual for each device optional device to be installed. The details pertaining to the installation and configuration)programming and setup) are included in these manuals.

CODE SALES TERMINAL CONNECTION OPTIONS:

There are several options available for “connecting” a GXP to the Code Sales so codes generated from the Sales Terminal can be redeemed at the GXP. The most common connection method used is to “**hard wire**” the Code Terminal to the GXP using a twisted pair cable that is ran through a conduit. The second most popular method is the “**Encryption**” method. This eliminates the need for a wired connection between the the Code Sales Terminal and the GXP by utilizing encryption technology at the Code Sales Terminal and Decryption technology at the GXP. The third connection is to use an “**Internet Connection**” between the Code Sales Terminal and the GXP. This method requires that an internet connection be available at the Code Sales terminal s as well as at the GXP machine. The internet connection is used to transmit the code authorization between the GXP and the Code Sales Terminal. The Internet Connection method requires an Internet Connect Module in the GXP. See the associated slide for connecting this device.

NETWORK SWITCH BOX

The Network Switch Box is used to connect up to three High Speed devices to a single incoming Ethernet line.

INSTALLATION:

- The high speed device cables and network switch box power cable were installed (routed) at the factory.
- The network switch box was disconnected prior to shipping and packaged in a separate container. To determine where to place this box in the machine, find the location of the cable terminations were factory routed and plug them into the box. The network switch box was located in the machine in an area where it can be easily installed/removed, the indicators can be easily viewed, and where the cables could be routed to it.

TROUBLESHOOTING:

Check the switch box to confirm that the power indicator is glowing.

Use the lights on the network switch box to determine if network data is flowing on the ports that are connected to each of the high speed devices. If the a network device is not operating properly then bypass the network switch box and plug the high speed device directly into the incoming Ethernet line. If the device is working properly when directly connected to the incoming Ethernet line, confirm that the switchbox has power and troubleshoot the switch box connections.

NETWORKING GXP'S

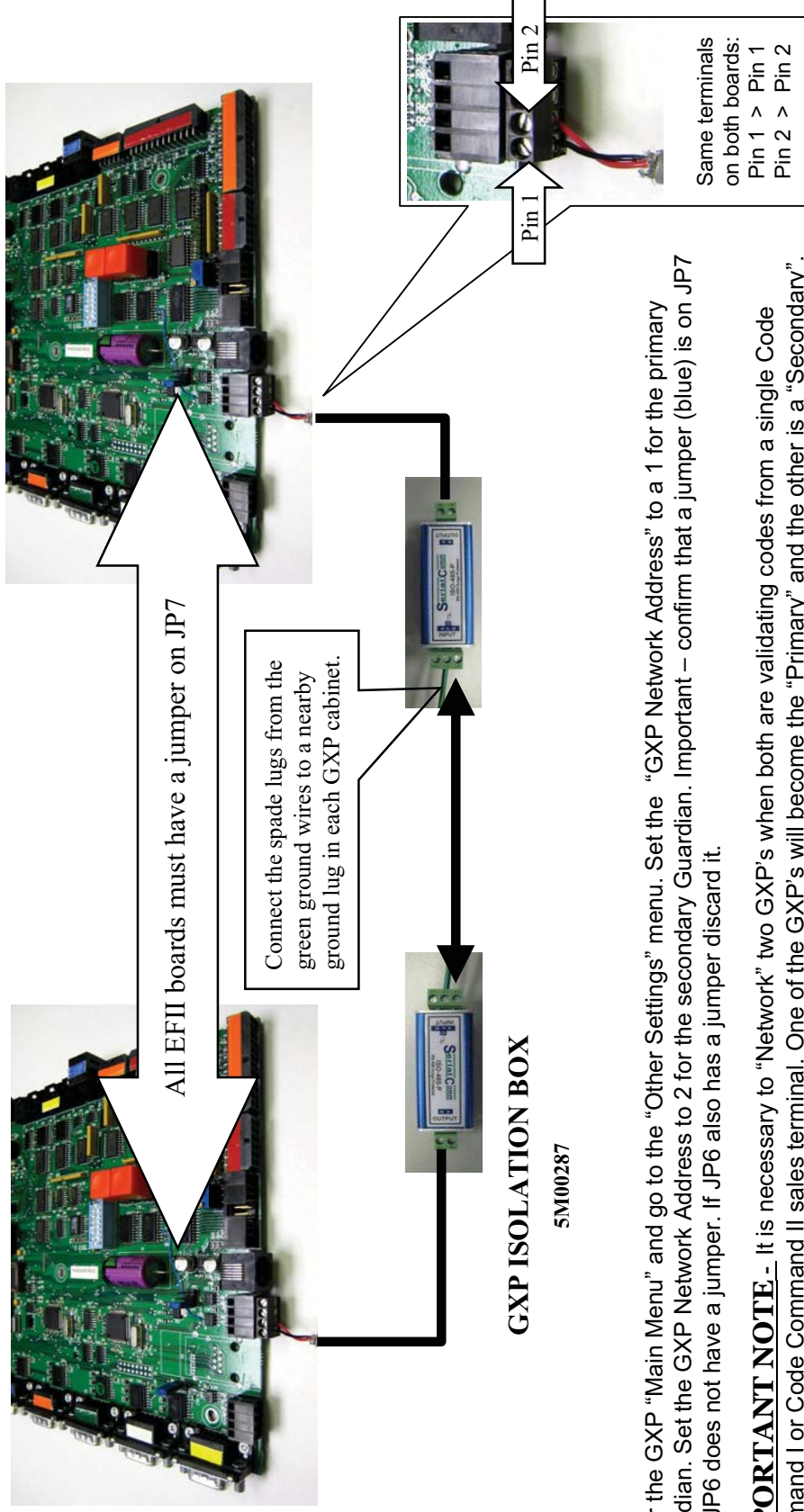

Enter the GXP "Main Menu" and go to the "Other Settings" menu. Set the "GXP Network Address" to a 1 for the primary Guardian. Set the GXP Network Address to 2 for the secondary Guardian. Important – confirm that a jumper (blue) is on JP7 and JP6 does not have a jumper. If JP6 also has a jumper discard it.

IMPORTANT NOTE - It is necessary to "Network" two GXP's when both are validating codes from a single Code Command I or Code Command II sales terminal. One of the GXP's will become the "Primary" and the other is a "Secondary". The Primary GXP is the one that will be hard-wired to the Code Command sales terminal.

STEPS REQUIRED TO ENABLE NETWORKING GUARDIANS

Note - The controller in the GXP must be at least a Rev 5 assembly, include the RS485 connector on the PCB, and have program version 3.050 or higher.
The "primary" Guardian is the Guardian where the connections are made to the devices you want to share with the secondary Guardians.

TROUBLESHOOTING:

•When communication is established between the Guardians the Configuration Report will display GXP network CONNECTED.

SitePRO CARD & REMOTE MONITORING SYSTEM

ETHERNET TERMINATIONS:

There are two connection types available for connecting a SitePRO server to a GXP, each requires a different Ethernet cable pin out. The first is a "direct" connection from the SitePRO server to the GXP. Direct means there are no other Network Devices (switch, hub or router) between the SitePRO server and the GXP. This requires a "crossover" pin out for the Ethernet cable. If a Network Device is present between the SitePRO server and GXP then a "straight" (straight through) pin out is required for the Ethernet cable. See the following table for the pin out. In either case it does not matter which RJ45 (at end of cable) plugs into a particular device.

STRAIGHT	
Pin 1	Pin 1
Pin 2	Pin 2
Pin 3	Pin 3
Pin 4	Pin 4
Pin 5	Pin 5
Pin 6	Pin 6
Pin 7	Pin 7
Pin 8	Pin 8

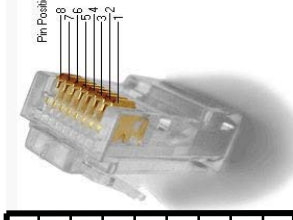

CROSSOVER	
Pin 1	Pin 3
Pin 2	Pin 6
Pin 3	Pin 1
Pin 4	Pin 4
Pin 5	Pin 5
Pin 6	Pin 2
Pin 7	Pin 7
Pin 8	Pin 8

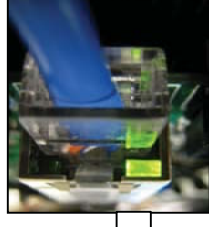
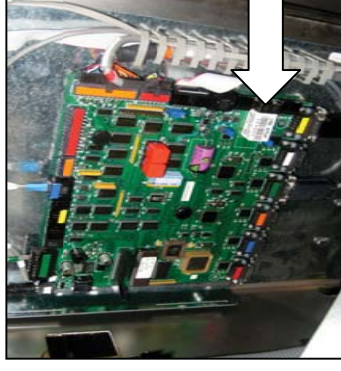

CONNECTING SitePRO TO THE GXP:

Connect the Ethernet cable coming from the conduit to the Ethernet module on the EFIII control board. See following pictures. When connected properly the IP address for the pay station can be viewed in the "Configuration Report" Menu. Access the Main Menu in the pay station to see this report.

The bottom LED should be on green steady. The top LED should flash green when data is transmitting. Data should be transmitting at least once every 20 seconds. No flashing green light means no data present – check terminations at both ends and make sure the terminations are not inverted from one end to the other.

CONFIGURING SitePRO IN THE GXP:

Note – Requires version 3.079 or newer in the GXP EF Control Module. These are typical settings. They may be different depending on your network configuration. The SitePRO technical support can help you with this.

Access the Main Menu in the GXP.

In the Credit Settings menu select "SitePRO" as the card system type.

Set the local IP address to 010.001.010.101.

Set the local port to 0.

Set the subnet mask to 255.000.000.000.

Set the remote IP address for the PC that the Satellite server is running on to 010.001.010.100

Set the remote port to 10001.

Make sure that Location ID under Other Settings is set to 1.

TROUBLESHOOTING:

Reset the GXP after making changes to the network settings in the Credit Settings menu to activate them.

Use the Configuration Menu to see the current settings read from the Ethernet module.

The EF Control Module in the GXP must be equipped with the Ethernet connection shown in the picture - the "EFIII Controller".

WASHGEAR CARD SYSTEM

ETHERNET TERMINATIONS:

The Ethernet connections for the Washgear System are "Normal" (straight through) connections from one cable end to the other. See the following table for the pin out. It does not matter which RJ45 (at end of cable) plugs into a particular device. The GXP will connect to the "switch box" supplied with the Washgear system. The EF Control Module in the GXP must be equipped with the Ethernet connection shown in the picture - the "EFIII Controller".

NORMAL	
Pin 1	Pin 1
Pin 2	Pin 2
Pin 3	Pin 3
Pin 4	Pin 4
Pin 5	Pin 5
Pin 6	Pin 6
Pin 7	Pin 7
Pin 8	Pin 8

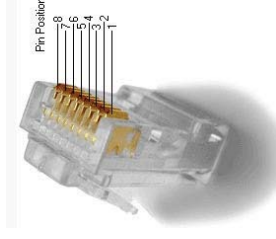

CONNECTING WASHGEAR TO THE GXP:

Connect the Ethernet cable in the GXP to the Ethernet module on the EFIII control board. See following pictures. Connect the other end of the cable to the Network Switch Box that is also connected to the PC running the Washgear application. When connected properly the IP address for the pay station can be viewed in the "Configuration Report" Menu... Access the Main Menu in the pay station to see this report.

The bottom LED should be on green steady. The top LED should flash green when data is transmitting. Data should be transmitting at least once every 20 seconds. No flashing green light means no data present – check terminations at both ends and make sure the terminations are not inverted from one end to the other.

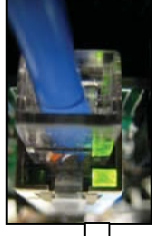
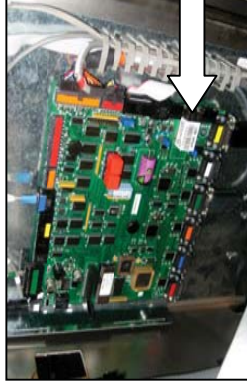

CONFIGURING WASHGEAR IN THE GXP:

Note – Requires version 2.009 or newer in the GXP EF Control Module.

If this is a new installation it would be best to get the Guardian up and running by itself before connecting to WashGear. In this way you know the Guardian is working. Set the time and program at least one wash value. Exit all the way out of the menu and press reset. It is not necessary to run the bay only that the Guardian does not have an error. If the Guardian is error free then access the Main Menu in the GXP.

Select "WashGear" as the card system type in the Credit Settings menu.

Select the next available "machine" number as the location ID in the Other Settings menu. Keep in mind that you will also need to use this same location ID as the identifier when setting up the WashGear software in the CardWorks application.

CONFIGURING WASHGEAR ON THE PC

Install WashGear's CardWorks OEM Standard Change-Makers edition if not currently installed in the WashGear computer hardware.

Use the "Manage Devices" feature to select SCM from the drop down menu..

Select the location identifier to match the location ID in the "Other Settings" menu of the Guardian XP.

For more information, contact your WashGear distributor.



TROUBLESHOOTING:

A current version of the Washgear program, one that recognizes a Standard Change-Makers pay station, must be installed on the PC running the Card Works program. Contact your Washgear supplier to identify the version required.

WASHCARD CARD SYSTEM

ETHERNET TERMINATIONS:

The Ethernet connections for the Washcard System are "Normal" (straight through) connections from one cable end to the other. See the following table for the pin out. It does not matter which RJ45 (at end of cable) plugs into a particular device. The GXP will connect to the "switch box" supplied with the Washcard system. The EF Control Module in the GXP must be equipped with the Ethernet connection shown in the picture - the "EFIII Controller".

NORMAL	
Pin 1	Pin 1
Pin 2	Pin 2
Pin 3	Pin 3
Pin 4	Pin 4
Pin 5	Pin 5
Pin 6	Pin 6
Pin 7	Pin 7
Pin 8	Pin 8

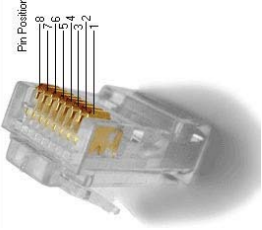

CONNECTING WASHCARD TO THE GXP:

Connect the Ethernet cable coming from the conduit to the Ethernet module on the EFIII control board. See following pictures. When connected properly the IP address for the pay station can be viewed in the "Configuration Report" Menu. Access the Main Menu in the pay station to see this report.

The bottom LED should be on green steady. The top LED should flash green when data is transmitting. Data should be transmitting at least once every 20 seconds. No flashing green light means no data present – check terminations at both ends and make sure the terminations are not inverted from one end to the other.

CONFIGURING WASHCARD IN THE GXP:

Note – Requires version 2.033 or newer in the GXP EF Control Module.
Access the Main Menu in the GXP.

Select "WashCard" as the card system type in the Credit Settings menu.

Clear the local IP address. This will allow the server to give the Ethernet module an IP address automatically (DHCP).

Set the local port to 10001. Actually almost any port will do this is just a default.

Clear the subnet mask. With the IP address cleared the subnet mask will be set automatically.

Set the remote IP address for the PC that the Satellite server is running on.

Set the remote port to the port the Satellite Server is using.

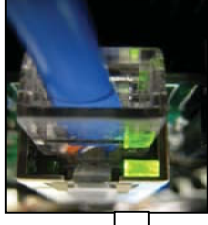
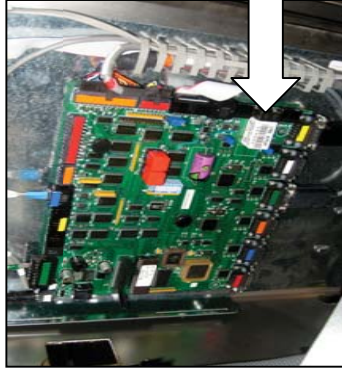

CONFIGURING WASHCARD ON THE PC

Install WashCard's Satellite Server *OEM Standard Charge-Makers* edition if not currently installed in the WashCard computer hardware. For more information, contact your WashCard distributor.

TROUBLESHOOTING:

Reset the GXP after making changes to the network setting in the Credit Settings menu to activate them. Use the Configuration Menu to see the current settings read from the Ethernet module.

ONE CARD CARD SYSTEM

OVERVIEW:

The One Card card system utilizes a PC that is located in the equipment room.

ETHERNET TERMINATIONS:

The Ethernet connections for the One Card System are "Normal" (straight through) connections from one cable end to the other. See the following table for the pin out. It does not matter which RJ45 (at end of cable) plugs into a particular device. The EF Control Module in the GXP must be equipped with the Ethernet connection shown in the picture - the "EFIII Controller".

NORMAL	
Pin 1	Pin 1
Pin 2	Pin 2
Pin 3	Pin 3
Pin 4	Pin 4
Pin 5	Pin 5
Pin 6	Pin 6
Pin 7	Pin 7
Pin 8	Pin 8

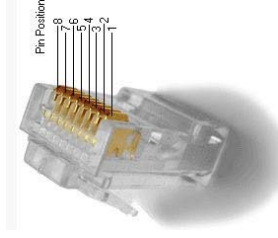

CONNECTING ONE CARD TO THE GXP:

Connect the Ethernet cable coming from the conduit to the Ethernet module on the EFIII control board. See following pictures. When connected properly the IP address for the pay station can be viewed in the "Configuration Report" Menu.. Access the Main Menu in the pay station to see this report.

The bottom LED should be on green steady. The top LED should flash green when data is transmitting. Data should be transmitting at least once every 20 seconds. No flashing green light means no data present – check terminations at both ends and make sure the terminations are not inverted from one end to the other.

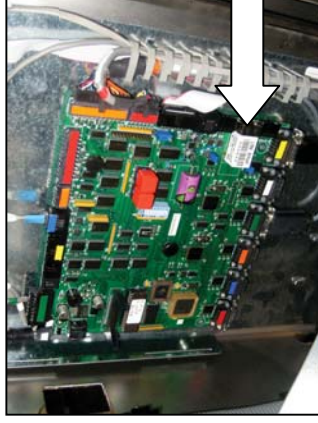

CONFIGURING THE ONE CARD IN THE GXP:

Note – Requires version 2.033 or newer in the GXP EF Control Module.

Access the Main Menu in the GXP.

Select "One Card" as the card system type in the Credit Settings menu..

Program in the fixed local IP address for the GXP system (recommended 192.168.1.101).

Program the Local Port to match the port setup in the One Card Software (recommended 13000).

Program in the fixed remote IP address for the PC system containing the One Card server software.

Program the remote Port to match the port setup in the One Card Software (recommended 13000).

CONFIGURING ONE CARD ON THE PC

Contact your One Card system provider for this.

TROUBLESHOOTING:

Reset the GXP after making changes to the network setting in the Credit Settings menu to activate them.

Use the Configuration Menu to see the current settings read from the Ethernet module.

QUICK PAY CARD SYSTEM

OVERVIEW: IMPORTANT – The Quick Pay Card Controller is not supplied by Standard Change-Makers.

The Quick Pay card controller assembly is not supplied with the GXP machine. It is purchased separately from a Quick Pay card system distributor. The GXP machine must be equipped with a Quick Pay card system interface kit. This interface kit is supplied by Standard Change-Makers and should be placed on order with the GXP machine. The kit includes everything needed to connect a Quick Pay controller to the GXP machine. The Quick Pay *card controller assembly* is mounted inside the GXP and is used much like a modem terminal to authorize cards that are inserted into the card reader on the front of the GXP machine. Install the Quick Pay controller in the bracket located in the bottom right corner of the machine, just below the GXP Controller Module.

CONNECTING THE QUICK PAY TO THE GXP:

Connect 24VDC from the junction box to the COM (NEG) HOT(+24VDC) terminals.
Connect the Com cable (4C00394) between J2 on the EF2 controller and the com terminal on the Quick Pay.
Connect A phone line to the Quick Pay controller.

CONFIGURING QUICK PAY IN THE GXP:

Note – Requires version 2.008 or newer in the GXP EF Control Module.
Access the Main Menu in the GXP.
Select “Quick Pay” as the card system type in the Credit Settings menu.

SETTING UP THE QUICK PAY CONTROLLER:

To program the merchant parameters into the controller.

1. Put the controller in “TEST transaction” mode. See controller documents for how to do this.
2. Make a valid selection on the the GXP system.
3. Swipe the Merchant Programming Card. The Quick Pay Terminal Will acknowledge on its display that it has been programmed.
4. Turn off the “Test transaction” mode when done to process card normally.

TROUBLESHOOTING:

Quick Pay Credit card setup and test: Check the “Credit Settings” menu and verify the Quick Pay has been selected in the “Card System” menu. You can verify the card reader and internal connections by following the credit card demo mode test procedure outlined in this manual.

If the Quick Pay controller is not accepting the Merchant setup card correctly make sure the “allow instant auth” setting in the Credit Settings Menu is set to “No”

Contact your Quick Pay card system supplier for assistance in using the remote to program the Quick Pay card terminal.

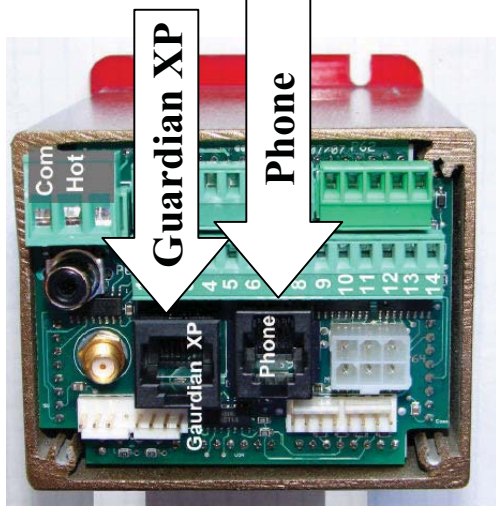

INTERCOM CONNECTIONS

page 1 of 2

The cable used for the call button and speaker should be specified in the Intercom Manual. If this information is not present we recommend using a twisted pair, shielded for the speaker/microphone to avoid hum and a twisted pair for the Call button. There is an Intercom timeout setting in Other Settings. This is the duration in seconds that the relay will switch the speaker to the intercom system when the Call Button is pressed. This requires 3.086 or 4.086 software or later.

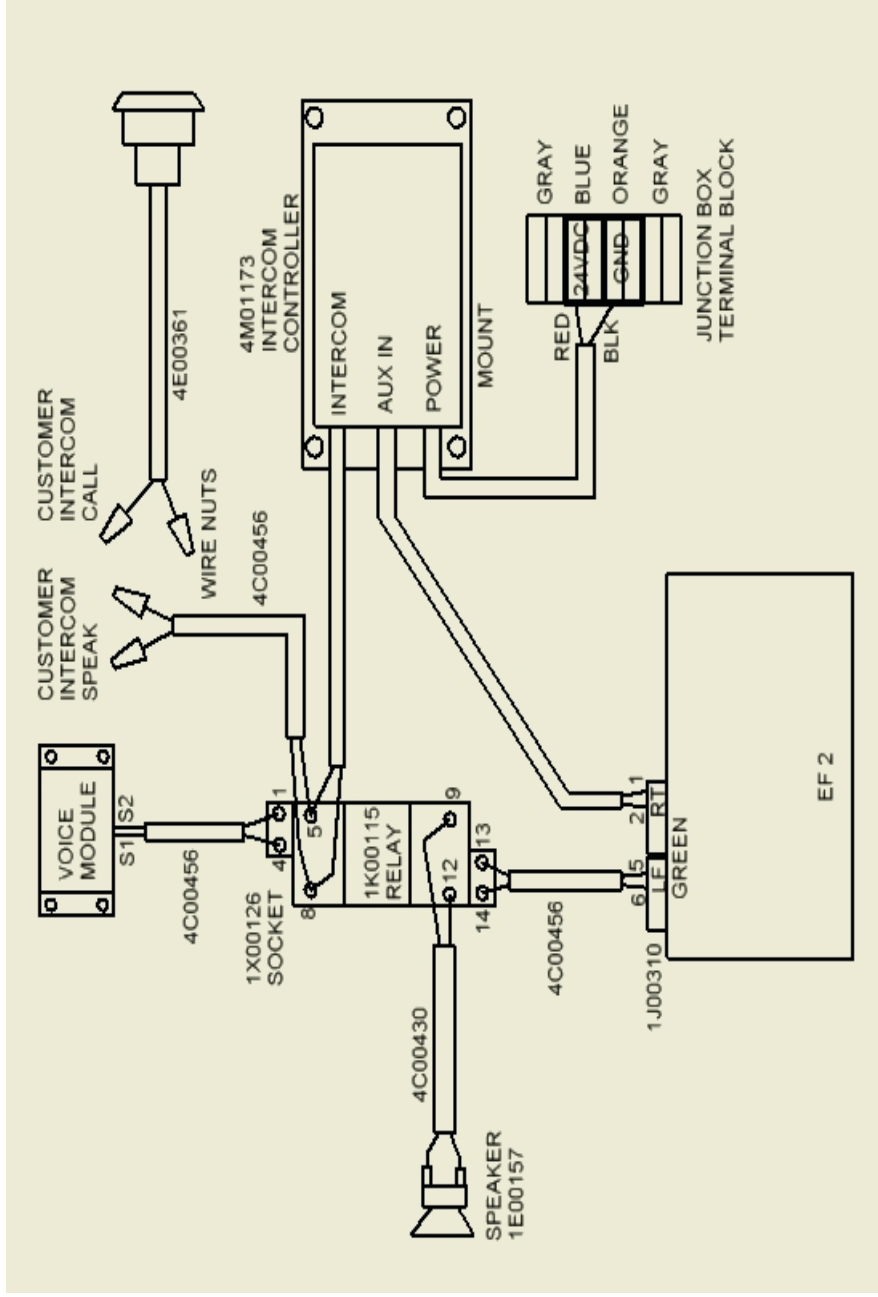

INTERCOM CONNECTIONS

page 2 of 2

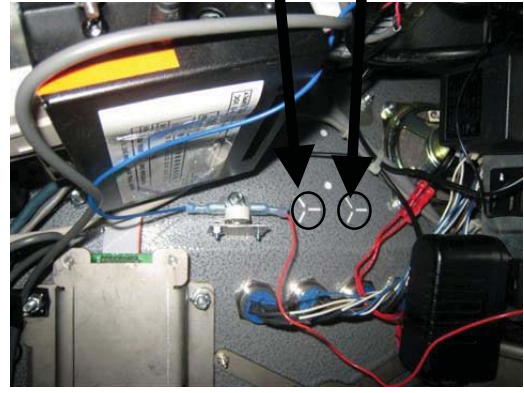
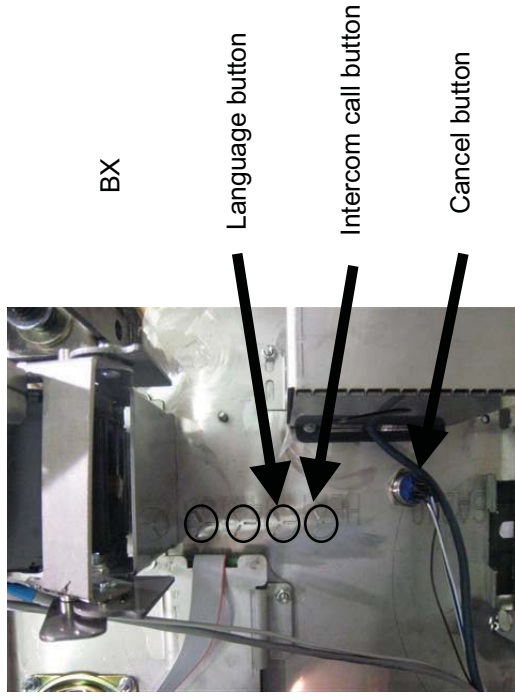
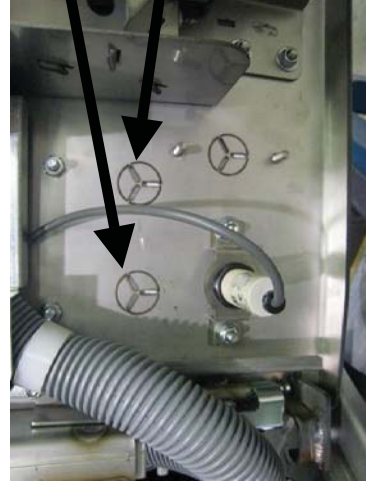

To install a button follow these steps.

1. Locate the button hole and poke through on the backside with a knife.
2. Cut the decal out from front side.
3. Remove knockout by using a screwdriver to rock the knockout back and forth.
4. File the broken tabs off inside the hole. Insert button and connect.

CONNECTING ANY POS TERMINAL TO A FUEL DISPENSER

Connecting to the Fuel Dispenser (Pump) Controller – Contact the person responsible for supporting the Fuel Dispenser.

The fuel dispenser controller will require the Unicam or Ryko Code-A-Wash version 4 protocol to be present. Contact the Fuel Dispenser (Gas Pump) support person to confirm which protocol is available in the fuel dispenser controller.

A 3 wire Is required between the Fuel Dispenser Controller and the Pump Isolation Module that was supplied with the Sales Terminal. See the Sales Terminal installation and operating guide for these connections.

POS4000 CODE TERMINAL

(page 1 of 2)

Connecting a Point Of Sale System - The controller in the GXP (EFII board must be equipped with an RS485 header and connector, and a program version 2.09 or higher. The wiring Connections for the RS485 cable are :

POS4000 GXP
 pin 2 -> pin 1
 pin 1 -> pin 2
 cable shield -> Earth Ground (connected to GXP cabinet ground lug or to a nearby Earth ground cable)

Important Note - The POS4000 terminal must be equipped with the version 8.22 software and set to communicate using the "Unitec" protocol.

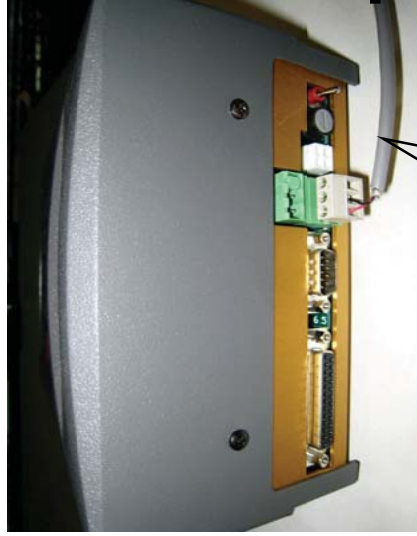

RED wire to "A"
 BLACK wire "B".
 Shield wire to "S"

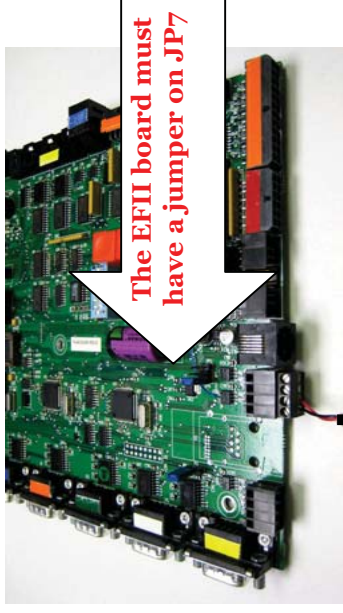

Connect the spade lug from the green ground wire to a nearby ground lug in the GXP cabinet.



GXP ISOLATION BOX

5M00287

Twisted pair w/shield

POS4000 GXP SETUP

page (2 of 2)

STEPS REQUIRED TO ENABLE THE GXP TO COMMUNICATE TO A POS4000

Note - The controller in the GXP must be a Rev.3 assembly, include the RS485 connector on the PCB, and have program version 2.09 or higher.

- Enter the GXP "Main Menu" and go to the "Other Settings" menu. Set the "Location ID". The POS4000 connected to the GXP was assigned an RS485 address at the time of installation. Determine what that address is and assign the GXP address (location ID) to the next highest number. If there is only one POS4000 used at the site then it is typically assigned address #1. The GXP location ID would be assigned address #2 in this common case.

- Go to "POS type" and set it "Unifec POS4000". Exit the Menu Mode. Wait 30 seconds before proceeding. This will allow time for the POS device to establish initial communication with the GXP.

- To confirm that the "Location ID" is set to the correct address and that the cable connections are correct, enter the Main Menu. If the display shows a "COMM LOST" error from the POS device upon entering the Main Menu mode, the initial communication was not established and you need to check the connections and Location ID setting. If an error is not listed then go to the the Config report menu. Step through this menu until you see the POS device listed. If you do not see the POS device listed the first time, and a COMM LOST error was not present upon entering the Main Menu mode, exit and re-enter the Main Menu and check for it again.

LABELING THE WASH PRICES ON THE POS4000 & GXP PLACARD – "Program 1" which is the top selection on the POS4000 decal, is the same as Selection #1 which is the bottom button on the GXP 1. Therefore, if you want the top button on the POS4000 to be the highest priced wash, the bottom button (Selection #1) on the GXP will be the highest priced wash. Be sure to order the GXP machine decal with this in mind.

Setting the Wash Selection Prices - The wash selection price is set in the POS4000. If the wash prices have been set in the GXP they will be overwritten by the POS4000.

TROUBLESHOOTING:

- POS 4000 will show up in our configuration report. If communication to the POS is lost, the GXP will record a "POS 4000-com lost" error.
- POS 4000 has a "link test" that the owner can use to confirm that the POS4000 can communicate with the GXP. This test is initiated at the POS4000 terminal. The POS will show a "time out" error if it loses communication with the GXP.
- Make sure the POS 4000 and the location ID are both selected in "OTHER SETTINGS".
- On advance replacements for the EFiI board, make sure the proper software and Rev board is used.
- Check the RS485 cable at both ends to confirm it is terminated correctly and plugged into the correct jacks on the GXP and POS4000.
- Check JP7. JP7 must be present on the EFiI board.

CCI – “HARD WIRED” TERMINAL SETUP

(page 1 of 2)

Connecting the Code Command I sales terminal to the Isolation Box

Code Command I sales terminal to Isolation Box – connect using cable supplied with the kit.

Isolation Box to GXP - The communication cable 4C00482 will connect the Isolation Box to the EFII Controller (in the GXP).

Isolation Box to Isolation Box - Use a twisted pair cable with a shield. Connect A to A and B to B. Connect the shield only at the CCI Isolation Box.

GXP Earth Ground – Both wires should be connected to an earth ground as near to the isolation box as possible.

CCI Earth Ground - Connect the “STORE GND” to a ground inside the store. Connect the “POS CHASSIS” to the CCI terminal

Cash Register Connection – The cash register connection may require a converter connector to convert from a DB9 to an RJ45 style connector. The converter is not supplied with the Code Command equipment. These converters are typically a part of the cash register equipment package.

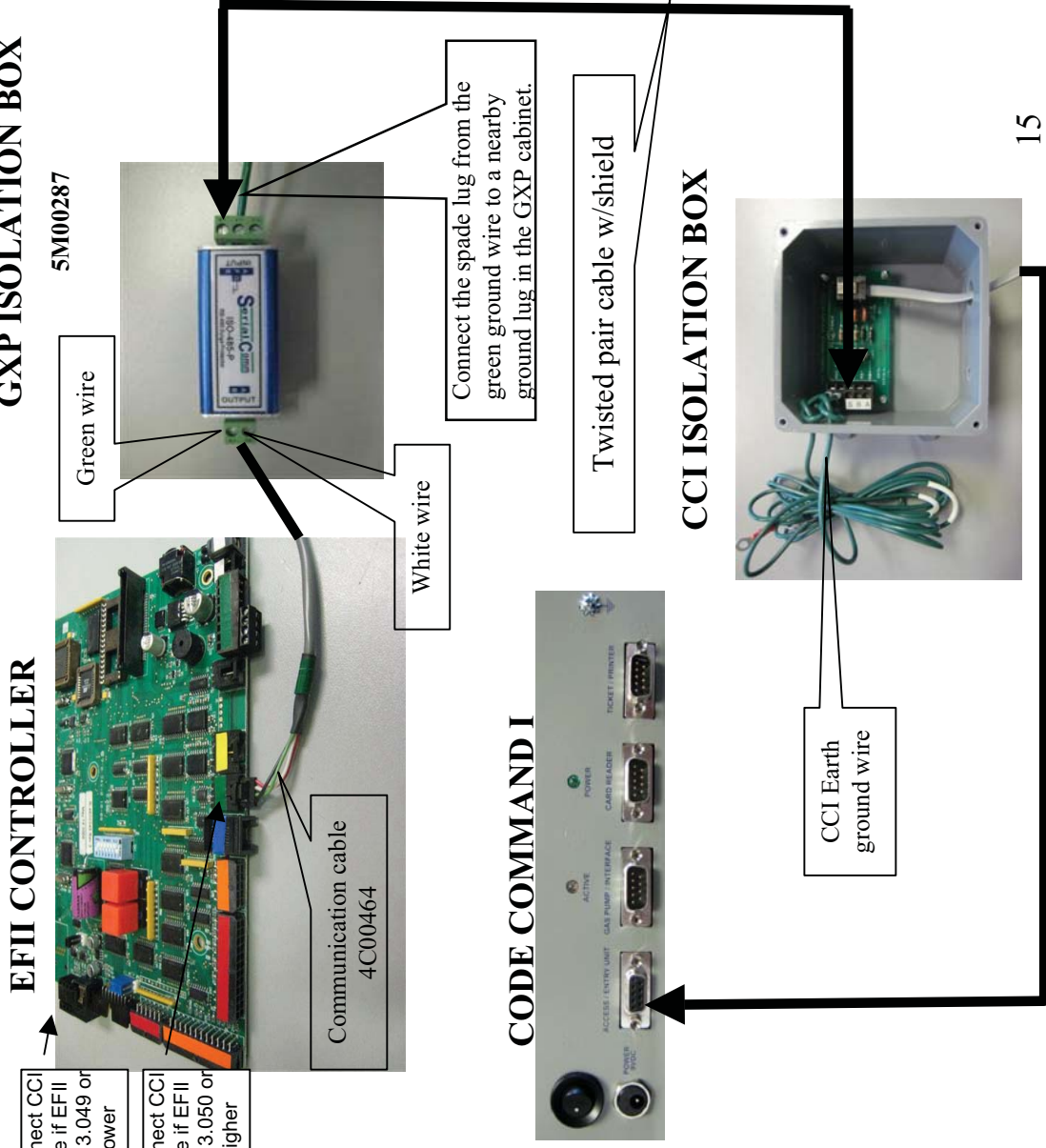

CCI “HARD WIRED” GXP SETUP

(page 2 of 2)

STEPS REQUIRED TO ENABLE THE GXP TO COMMUNICATE TO A CODE COMMAND I

Note - The control board in the GXP must be at least a **Rev 5 assembly**, including the RS485 connector J11 located on the top edge of the board. Software version must be **3.050 or higher**.

- Go to "POS type" in "OTHER SETTINGS" and set it to "Code Command I".
- Go to "Other Settings" and select the appropriate location ID. Exit the Menu Mode. Wait 30 seconds before proceeding. This will allow time for the POS device to establish initial communication with the GXP.
- JP7 on the EFII control board must have a blue jumper installed.
- To confirm that the cable connections are correct, enter the Main Menu. If the display shows a "POS code COMM LOST" error from the POS device upon entering the Main Menu mode, the initial communication was not established and you need to check the connections and Location ID setting. If an error is not listed then go to the Configuration Report menu. Step through this menu until you see the POS system listed. If you do not see the Code Command I listed the first time, and a COMM LOST error was not present upon entering the Main Menu mode, exit and re-enter the Main Menu and check for it again.

TROUBLESHOOTING:

- Code Command I will show up in the Configuration Report. POS SYSTEM-CODE COMMAND I (if found) POS SYSTEM- NOT CONNECTED (if not found)
- If communication to the POS is lost, the GXP will display "POS code-EF com lost" error when entering the program menu.
- The Code Command I sales terminal will show a "Carwash not available" error if it loses communication with the GXP.
- On advance replacements for the EFII board, make sure the proper software and Rev board is used.
- Check the RS485 cable at both ends to confirm it is terminated correctly and plugged into the correct jacks on the GXP and Code Command I.
- Turn POS Off then On and check the software – Must be 3.08 or higher to communicate.

CCII- “HARD WIRED” GXP SETUP

(page 1 of 2)

The Hard Wired connection method requires a wired connection between the Code Command II and the GXP. The hard wired connection will be used by the GXP to request verification for One Time Use and Fleet Codes that are entered at the GXP. One Time Use codes are automatically available. Instructions for enabling Fleet codes are on the next page.

Software Requirements: CCII Terminal Software Rev 6.01.55 (Or higher) and GXP EFI Software Rev 3.085 (Or higher)

Program Setup in GXP: Under POS Settings select the **POS type** as “Code Command I”. The **number of code digits** and **auto enter after X digits** should match the local code size entered in the CCII.

GXP Earth Ground : Both wires should be connected to an earth ground as near to the isolation box as possible.

Wires, Conduits, Terminations– A Category 5 (CAT5) Ethernet cable is required between the GXP and the CCII at the site. This cable can be routed in an existing conduit that is carrying other data signals.

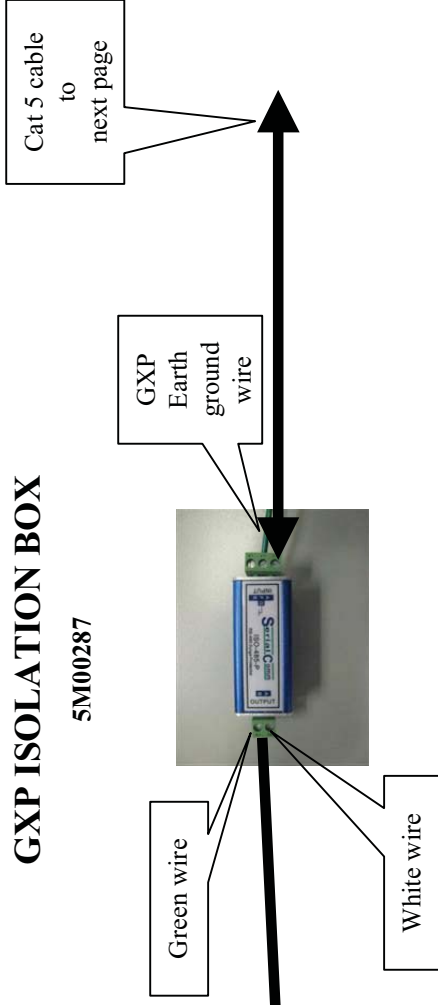
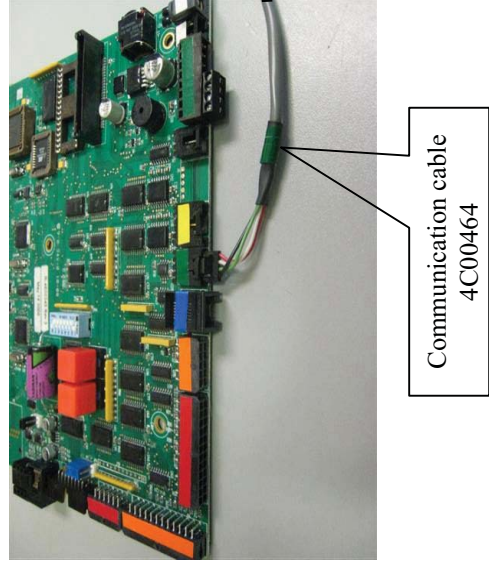

CCII- “HARD WIRED” TERMINIAL SETUP

(page 2 of 2)

Steps required to enable Fleet Codes:

- Press SETUP and then OK at password screen to enter into the program screen. Press POS and then check the box "Fleet Enabled".
- You will be prompted to enter a pass code (provided by Kesseltronics) to enable fleet codes. You must contact Kesseltronics (450) 458-8826 the day of setting up the fleet code application and ask for a pass code for a Code Command II fleet code installation.
- the local code size will select the number of digits for a One Time Use code. Fleet codes will be 6 digits.
- if you only want to issue fleet codes check Fleet Only. If you wish to be able to sell One Time Use codes as well as Fleet codes leave this unchecked.
- Press Ok.
- Go back into setup and press the COM button.
- Under tab 3 select Printer.
- Under tab 4 select PDQ Access
- Press OK.
- For instructions on how to setup Fleet code customers and issue Fleet codes please see the Code Command II Operators manual 8M00587.

Cat 5 cable to
previous page



Please see the Code
Command II
Operators manual
8M00587 for
connection details



Troubleshooting – Go to setup screen and press the Reset CE button. Restore to LOCAL factory defaults will restore the wired settings. The CCII will reboot when you do this.

CCII “ENCRYPTED” TERMINAL SETUP

(page 1 of 2)

CONNECTION AND SETUP AT THE SALES TERMINAL:

- See the installation and Operating guide of the sales terminal for this information. Important – make sure the gas pump isolator and cash register isolator is connected properly..
- Under Setup press the POS Type button to display the “Config POS Type” screen.
- *Satellite Code Length*, select the number of digits (5 OR 6) you want your wash codes to be. The more digits the more secure your code will be, but fewer codes can be issued for a day.
- *Max Satellites*, this is the number of CCII sales terminals in your system issuing encrypted codes. Codes 5 or 6 digits in length only allow up to 4 sales terminals. 7 digit codes will allow up to 10 sales terminals.
- Select a check box to determine which satellite your CCII sales terminal is. There can not be any duplicates. Each sales terminal is a satellite.
- *Max Progs*, this is the maximum number of washes (products) in your system.
- *Max Codes*, the maximum number of codes that can be issued in one day. It is calculated by the CCII based on Max Progs and Max Satellites. You can set this to a lower number to limit the number of accepted false wash codes. In example of one Code Command and four GXPs. Each GXP is suppose to do 100 washes a day. The Max Codes could be set to 400 at all of the sites. If you had only one GXP then Max Codes could be set to 100.
- *Network Mask*, this is a key used in the encryption to differentiate two adjacent systems. This can be any number you choose. It can also be changed if you want to cancel all issued wash codes.
- If your *Satellite Code Length* is 5 digits the recommended maximum *validation time* is 34 days. For a *Satellite Code Length* of 6 digits it is 60 days.

CII “ENCRYPTED” GXP SETUP

(page 2 of 2)

SETUP AT THE GXP :

- Make sure the Real Time Clock is set correctly. This will immediately affect the database when you turn it on in the next step.
- In the menu go to POS SETTINGS and press the down button. Press the down button after each entry item.
- POS type, select Encrypted.
- Each entry should match the entry under POS Type on the CCIi.
- Max Window only applies to the GXP. The CCIi does not use it. It is used to limit the number of valid codes for any day prior to the current day. Enter a number from 0 to the Max Codes. A zero disables the window.
- Important - Print the POS Settings and compare them to the settings in the CCIi. All settings except for Max Window have to match for authorization. Correct any settings that do not match then retest the system.

TROUBLESHOOTING:

- Go to the first screen in setup of the CCIi terminal and press the Reset CE button. Restore to REMOTE factory defaults will restore the encrypted settings. The CCIi will reboot when you do this. Repeat the steps outlined in the previous slide “Connection and Setup At The Sales Terminal”.

CCII- “INTERNET” CORTEX WEBSITE SETUP

(page 1 of 3)

SETUP AT THE CORTEX WEBSITE:

- Login using admin/admin
- Under Setup/Products click on “add new” and enter the wash names and any upsells.
- Under Setup/Payment Methods click on “add new” and enter CASH if you have a bill or coin acceptor. If you have a Datacap enter VISA and MASTERCARD.
- Under Setup/Promotions click on “add new”. Enter any Discount Types.
- Under “Devices at this site” click on “add new” and enter GXP “n” where “n” is the number used in the location ID.
- Under “Devices at this site” click on “add new” and enter CCII “n” where “n” is the serial number entered under Cortex Config.
- Under “Tools/Code List” print the list of Names that have been assigned to each *Promotion*, each *Product* and each *Payment Type*. This printout will also include the associated codes. **Save this for use in setting up the GXP**. These same exact names will be setup in the GXP. Capitalization and correct spelling must match for the names assigned in Cortex website and duplicated in the GXP setup.

CCII- “INTERNET” GXP SETUP

(page 2 of 3)

CONNECTION AND SETUP AT THE GXP :

Naming Conventions - The Cortex web site, the GXP and the Code Command II must all use the same naming conventions for “Payment Methods” and “Wash Names”.

Promotions / Discount Types – The Cortex system refers to “Promotions” as a label in the Cortex web site and the GXP refers to the same thing as a “Discount Type”. Cortex Promotions should not be confused with GXP Promotions. All Discount Types (Promotions) can have a custom name except TIME. If you are going to allow time based discounts you must enter “TIME” as a Promotion name at the Cortex server. Note – To setup the Discount Types in the “Discount Type Settings menu of the GXP, see the GXP Owners Manual for programming instructions. You will enter the Promotion codes created at the Cortex web site into the GXP. See the Cortex web site setup documentation for setting the Promotion names. This information is supplied by Kesseltronics.

Products / Button Names – The Cortex system refers to the wash selections as “Products”. The GXP refers to them as “Button Names” in the programming and setup menus. Note – setup the Button Names in the “Button Settings” menu of the GXP, see the GXP Owners Manual for programming instructions. See the Cortex web site setup documentation for setting the Product names. This information is supplied by Kesseltronics.

Payment Methods – These refer to the payment types your customer will use to purchase a wash. When setting up Payment Methods at the Cortex website the text must be entered exactly as shown below (case sensitive). Again, these must be entered exactly as they appear below. Cortex can group all credit cards (MASTERCARD, VISA, DISCOVER...) together into one Payment Method type or they can be separated should you wish to see the total accepted for each individual card. To group them together simply set them up in Cortex as “CREDIT”. To break them out individually list each credit card as a separate payment method; “VISA”, “MASTERCARD”, “DISCOVER”, “AMERICAN EXPRESS”, “DINNERS CLUB”, “GIFT” and “FLEET”.

Note – See the Cortex web site setup documentation for direction on setting the Payment names. The Payment Methods are preset in the GXP so they do not need to be manually setup.

CCII- “INTERNET” TERMINAL SETUP

(page 3 of 3)

CONNECTION AND SETUP AT THE SALES TERMINAL:

- If the Washcode application is running press the “Log off” button. Press “No” when you are asked if you want to print a shift report. Press the “Setup” button. The password should be blank, then press “OK”.
- Under Programs (2nd column, 1st button) starting with the top wash at 1 enter the name and value for each wash. Include any upsells and their values.
- Press the “more->” button and then “Cortex Config” (2nd column, 3rd button).
- Enter the serial number you used in the Cortex Web Instructions.
- Check the boxes “Enable Cortex Sales”, “Enable Cortex Code”, “Get codes from Cortex”
- Enter the URL from the sales order into both URL locations.
- Using the codes printed in step 8 of the Cortex Web Instruction enter all payment methods (Pymt Mtd) using the code number for CASH.
- Important - Using the codes printed in step 8 of the Cortex Web Instruction enter all of the wash codes. The top wash starts with Prog 1. Don't forget to enter any upsell codes. Print the Cortex Report for comparison to the Cortex web site. You will find the Cortex Report under Diagnostics Report. The Cortex Report will tell you what Product/Button Names and Payment Types have been found by the GXP. For a correct audit with Cortex all Product/Button Names must be found.

TROUBLESHOOTING:

- Print the Discount Types to check the Cortex ID entered at the Cortex web site.

EXPRESSWAY OVERPASS SYSTEM

CONNECTION AND





Standard Change-Makers, Inc.

3130 N. Mitthoeffer Road

Indianapolis, IN 46235

Toll Free: 1-800-968-6955

Phone: 317-899-6966

Fax: 317-899-6977

Web Site: www.standardchange.com

FOR SERVICE OR TECHNICAL SUPPORT:

Call: 1-800-968-6955

E-Mail: service@standardchange.com

SALES REPRESENTATIVES:

Eastern U.S.: Dan Wagner

PH: 610.942.4215 EM: dwagner@standardchange.com

East-Central U.S.: Mike Enz

PH: 937.679.6090 EM: menz@standardchange.com

West-Central U.S.: Dale Hughson

PH: 319.239.2481 EM: dhughson@standardchange.com

Western U.S.: Mike Coons & Barb McColly

PH: 800.968.6955 x111 EM: mcoons@standardchange.com

PH: 800.968.6955 x110 EM: bmccolly@standardchange.com

Canada: Paul Thompson

PH: 514.502.0124 EM: sales@standardchange.ca