



Standard

Change-Makers, Inc.

P.O. Box 36550

Indianapolis, IN 46236-0550

3130 N. Mitthoeffer Road

Indianapolis, IN 46235-2400

1-800-968-6955

Phone: (317) 899-6966

Fax: (317) 899-6977

F53-BILL DISPENSER

Fujitsu™ Dual Note Operation Manual

Part #8M00504 Rev. 1

For Maintenance Purposes Only

AUTOMATED TELLER MACHINE / CASH DISPENSER

F53 - BILL DISPENSER UNIT

OPERATOR'S GUIDE

FUJITSU FRONTECH

8M00504

REVISION RECORD

| EDITION | DATA ISSUED | DESCRIPTION OF CHANGE | PAGE (S) |
|-----------------------------------|----------------|------------------------------------|------------|
| 01 | August 2004 | Original issue | |
| 02 | September 2004 | Changed § 2.1.6 | |
| 03 | September 2004 | Add Environment notice | 26 |
| 04 | April 2005 | Change Photographs of the cassette | 2-13,14,15 |
| | | | |
| | | | |
| | | | |
| | | | |
| | | | |
| | | | |
| | | | |
| | | | |
| | | | |
| | | | |
| | | | |
| | | | |
| | | | |
| | | | |
| | | | |
| | | | |
| Document Code No.: P1KD02881-B001 | | | |

Date: Month, Year

Foreword

Before operating F56/53, please read this guide carefully to enable proper use.
 Keep this guide in a safe and handy place for easy reference whenever necessary.

CONTENTS

| | |
|--|------------|
| CHAPTER 1 OUTLINE | 1-1 |
| 1.1 Pool Type (Front Access) | 1-1 |
| 1.2 Pool Type (Rear Access) | 1-1 |
| 1.3 Tray Type | 1-2 |
| 1.4 Spray Type | 1-2 |
| CHAPTER 2 CASH CASSETTE | 2-1 |
| 2.1 Cash Cassette | 2-1 |
| 2.1.1 Parts | 2-1 |
| 2.1.2 Inserting and removing a cash cassette | 2-3 |
| 2.1.3 Loading bill | 2-6 |
| 2.1.4 Setting the bill type | 2-10 |
| 2.1.5 How to handle a cassette | 2-12 |
| 2.1.6 Notes on loading bills | 2-13 |

CHAPTER 1 OUTLINE

The figure below shows F56 bill dispenser.

There are two types of Top units available.

1.1 Pool Type(Front Access)

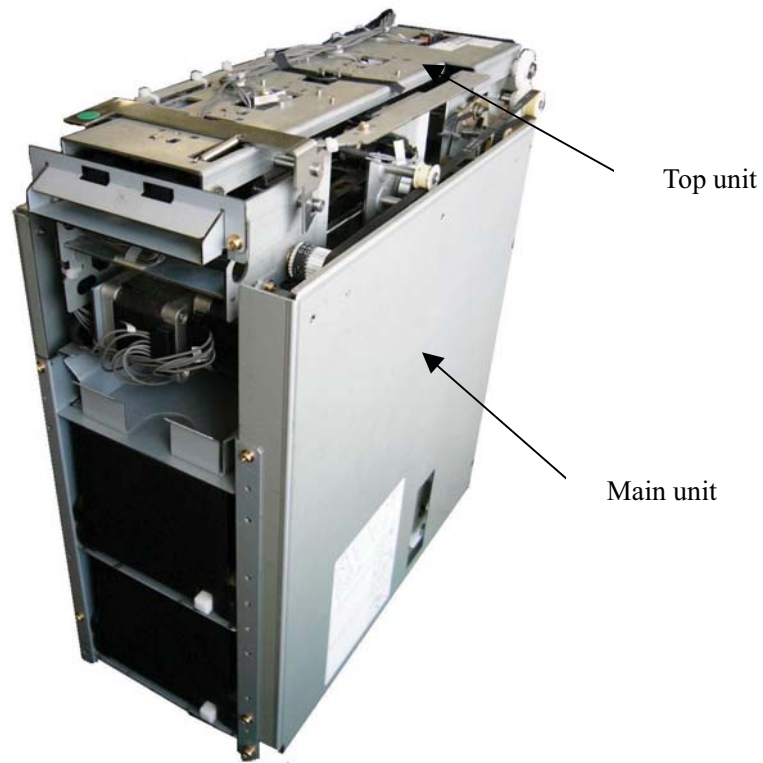

1.2 Pool Type(Rear Access)

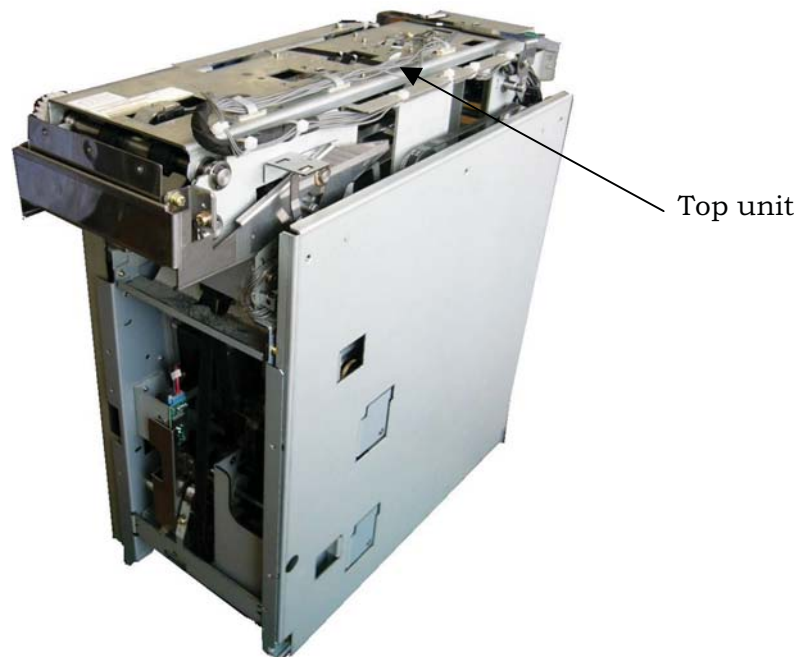

The figure below shows F53 bill dispenser.
There are two types of Top units available.

1.3 Tray type

Top unit



1.4 Spray type

Top unit



CHAPTER 2 CASH CASSETTE

2.1 Cash Cassette

F56/F53 can support up to 6 cassettes and each of them consists of the parts listed in Section 2.1.1.

2.1.1 Parts

| | |
|----------------------|---|
| Lid: | Top cover of the cash cassette |
| Handle: | Used for carrying the cash cassette |
| Chassis: | Main frame of the cash cassette |
| Denomination magnet: | Used to specify bill denomination for each cassette |
| Magnet slot label: | Identifies each of magnet slots where denomination magnets are inserted |
| Pressure plate: | Used to hold a bill bunch loaded into the cash cassette |
| Side guide: | Used to align the long edges of the bills in the cash cassette |
| Rear guide: | Used to align the short edges of the bills in the cash cassette |

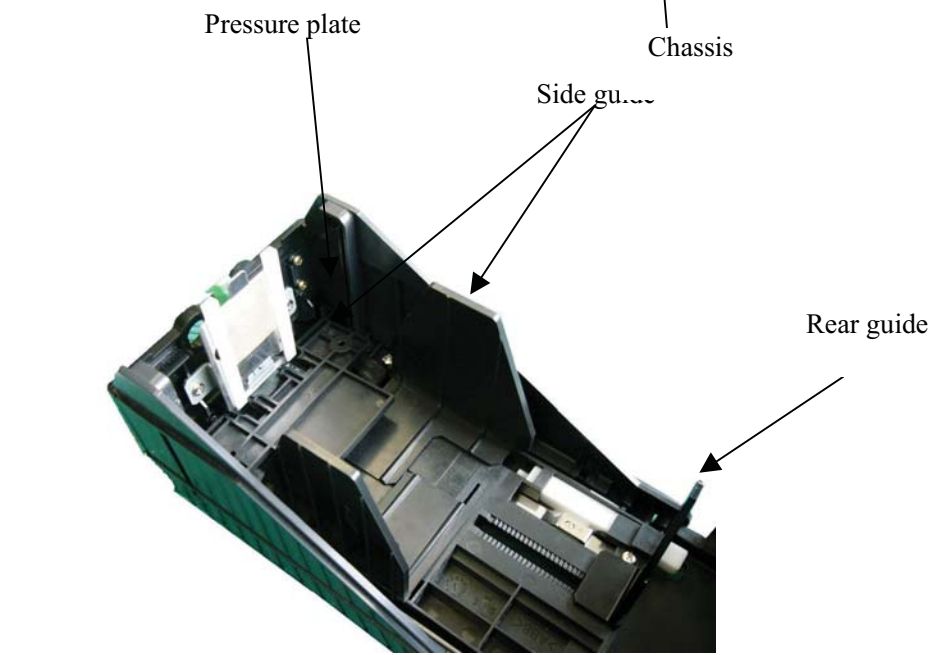
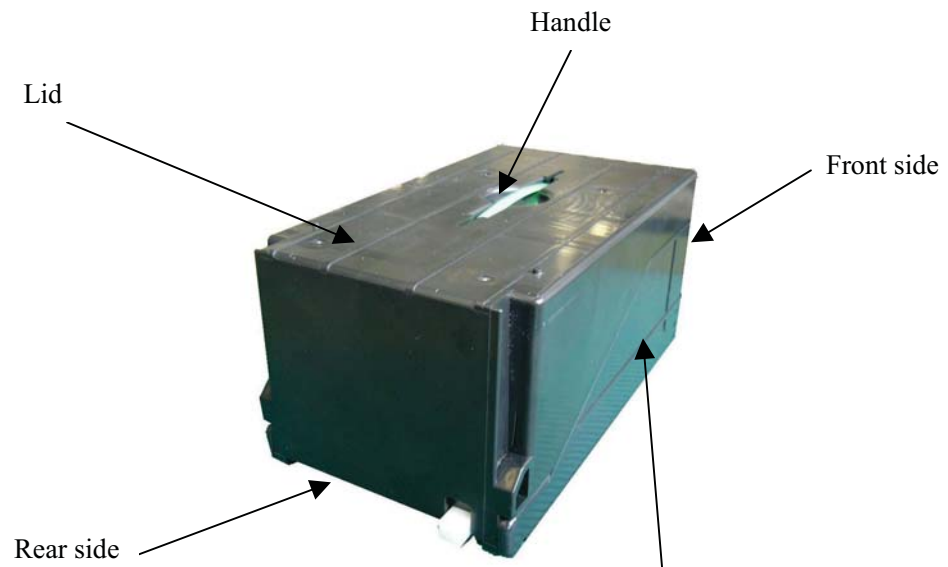

2.1.2 Inserting and removing a cash cassette from the dispenser

-Removing a cassette

- (1) Press and hold the push-button at the bottom right corner of a cassette and remove the cassette from the dispenser.

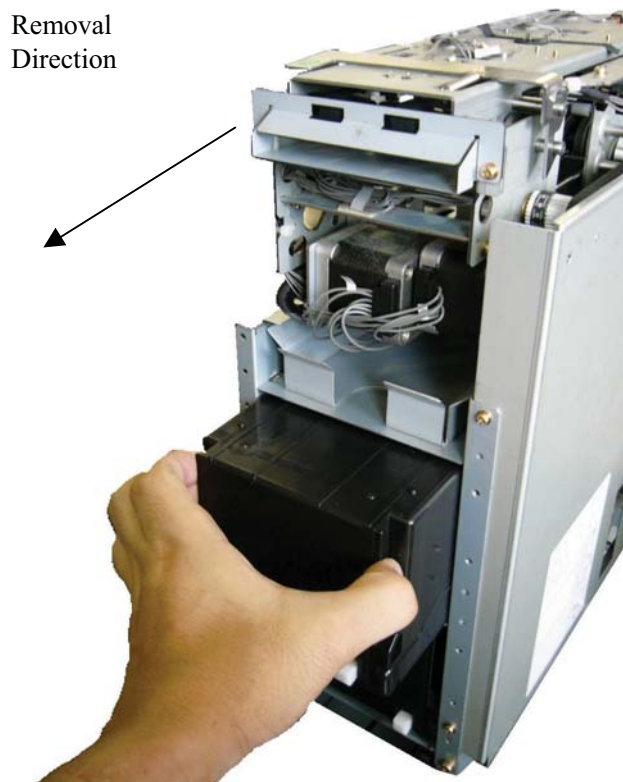
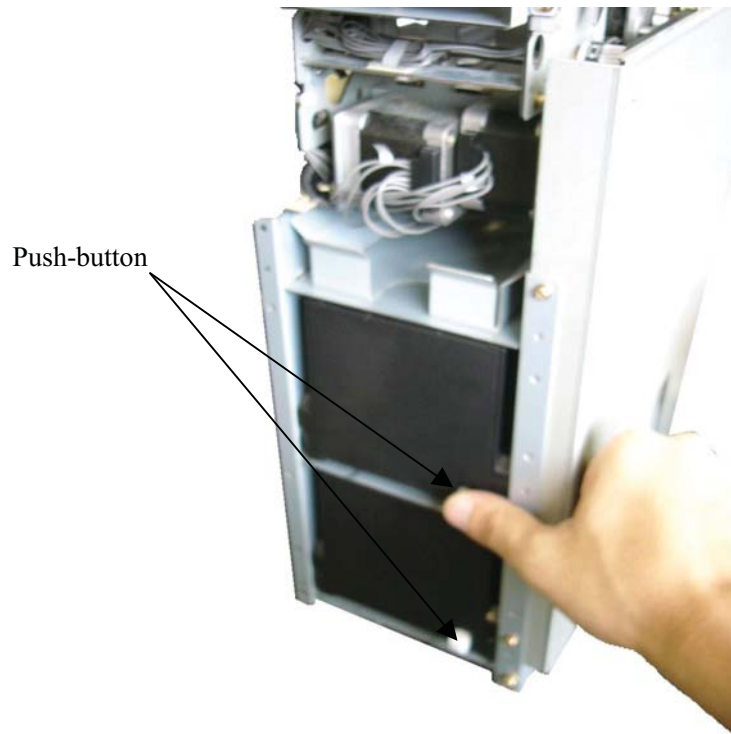

Removal
Direction



Caution:

Be careful not to pinch your fingers between the dispenser and cassette.

-Inserting a cassette

(1) Insert a cassette into the dispenser and push it forward as far as it goes.

Insertion
Direction

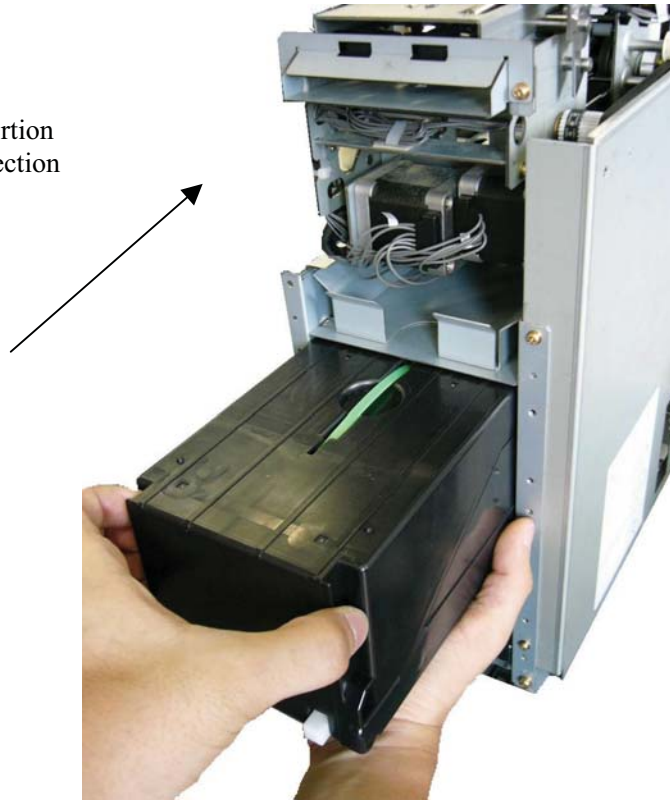

Notes:

- 1.All cash cassettes used in the F56/F53 are compatible with each other.
- 2.The F56/F53 cannot start operation when no cassette is installed.

Caution:

Be careful not to pinch your fingers between the dispenser and cassette.

2.1.3 Loading bills

(1) Push and hold the green button on the front side of a cassette to release the lock and open the lid.

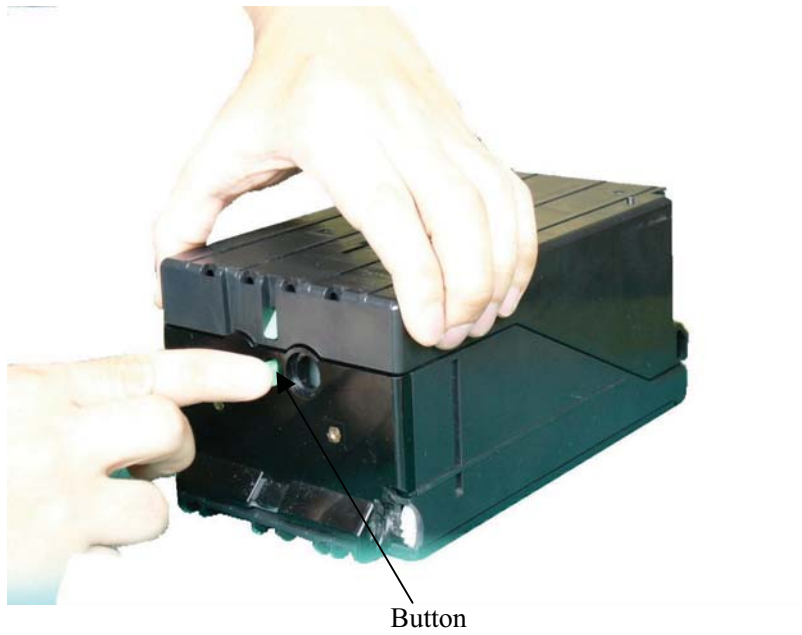

(2) Lift the lid up in the direction of arrow “b” to completely open the cassette.



- (3) Pull the pressure plate toward you and raise it along the grooves on both sides. When the pressure plate reaches the top of the groove, push the pressure plate forward so that it can be settled in the slots leading out of the grooves.

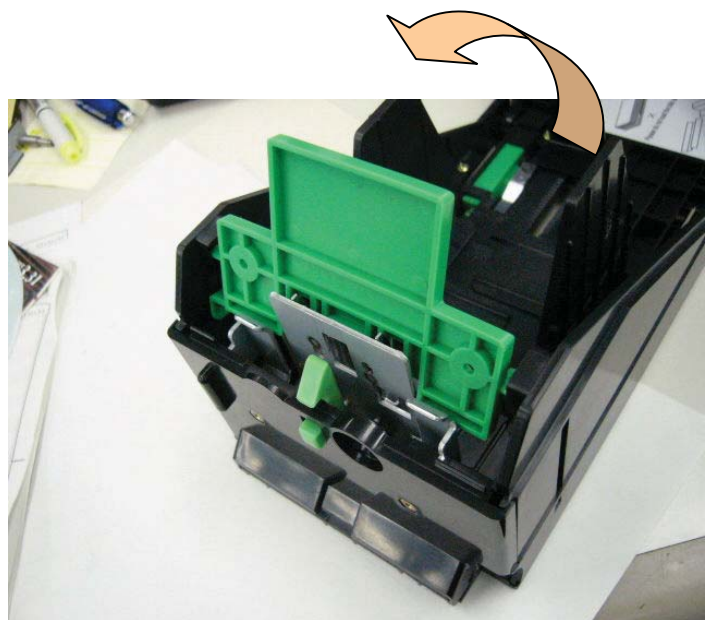
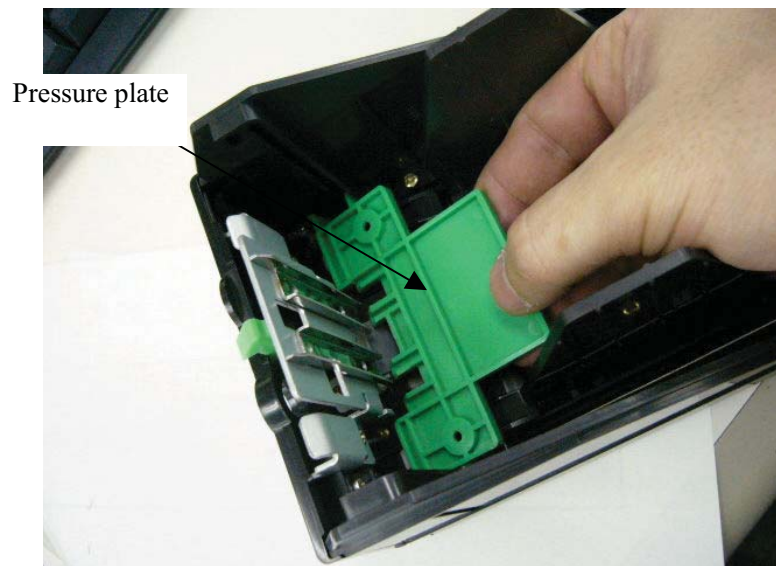

(4) Before loading bills into the cassette, jog and align them.

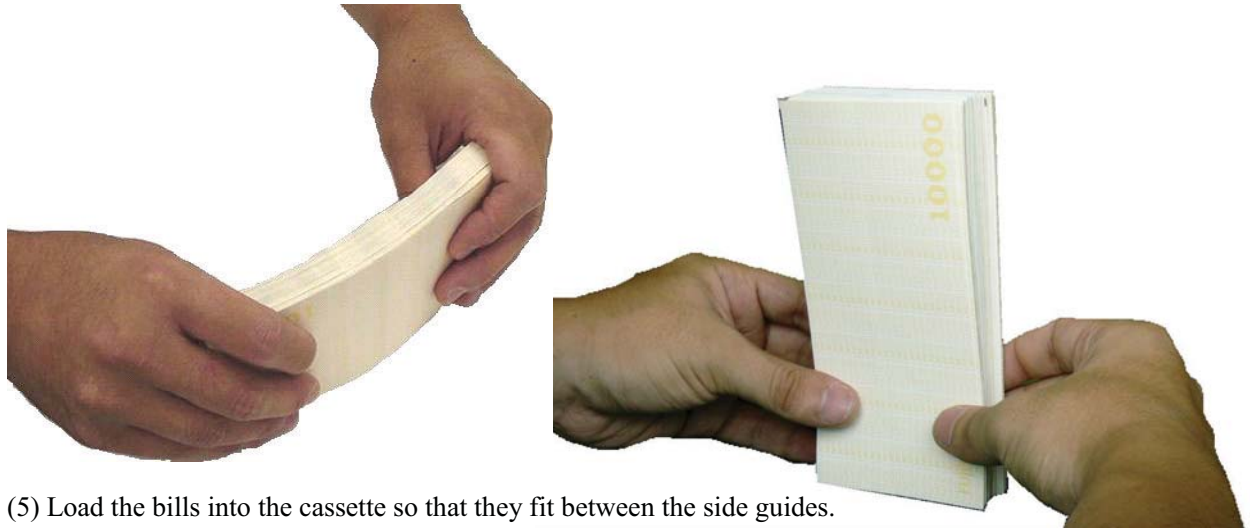

(5) Load the bills into the cassette so that they fit between the side guides.



(6) Lower down the pressure plate to hold the loaded bills.



(7) Close the lid.

(8) Insert the cassette into the dispenser and push it as far as it goes.

Notes:

1. Do not load more than 500 bills into one cassette.
(Reference value, New bills which thickness is 0.12mm)
2. Do not cram the bill.

2.1.4 Setting bill denomination for a cash cassette

Look at “Denomination magnet combination table” on page 2-11 and find a combination of denomination magnets that corresponds to a denomination you wish to set. There are four magnet slots available and two of them are always used to specify one denomination for a cash cassette.

- (1) Insert two denomination magnets into two slots respectively with their white top face facing upward and their white side face inserted first.

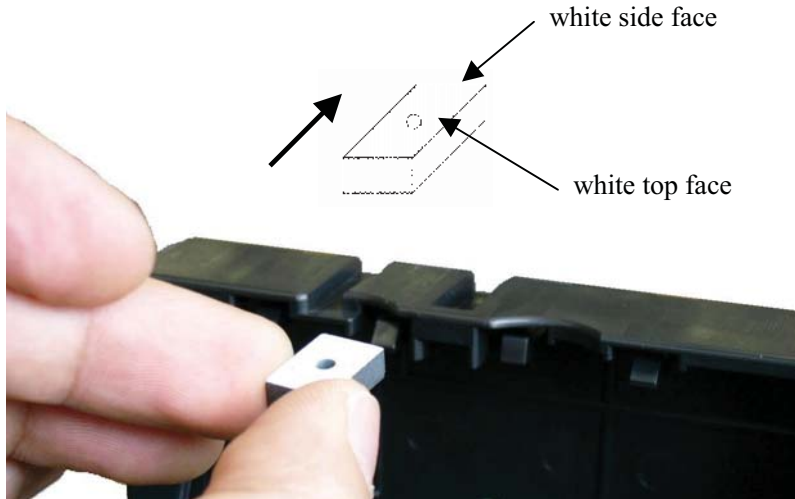

*Make sure that denomination magnets are completely fitted into slots under a claw.



The following shows labels attached below each slot which denomination magnets are inserted into.

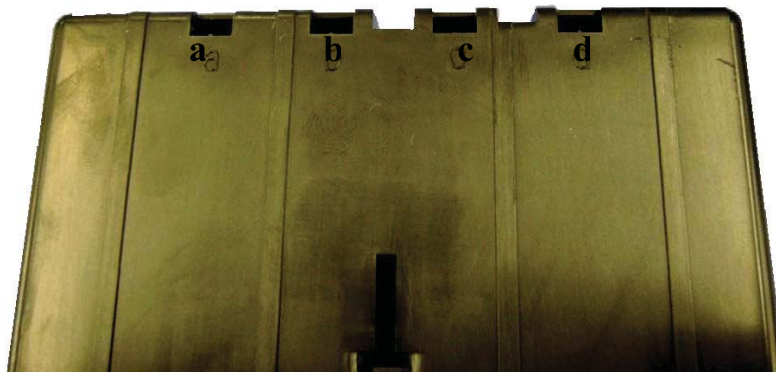

| | a | b | c | d |
|----------|----------|----------|----------|----------|
| A | ● | ● | | |
| B | ● | | ● | |
| C | ● | | | ● |
| D | | ● | ● | |
| E | | ● | | ● |
| F | | | ● | ● |

Denomination magnet combination table

With its 4 magnet slots, each cassette can support 6 different magnet combinations, that is, 6 different denominations.

2.1.5 How to handle a cassette

Make sure to hold the handle on top of a cash cassette when carrying.

Good example

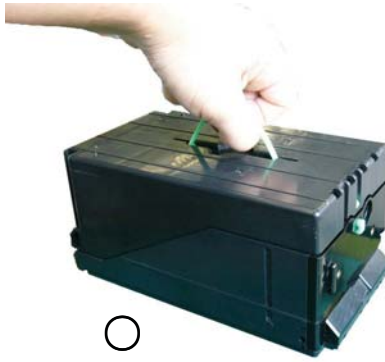

Bad example

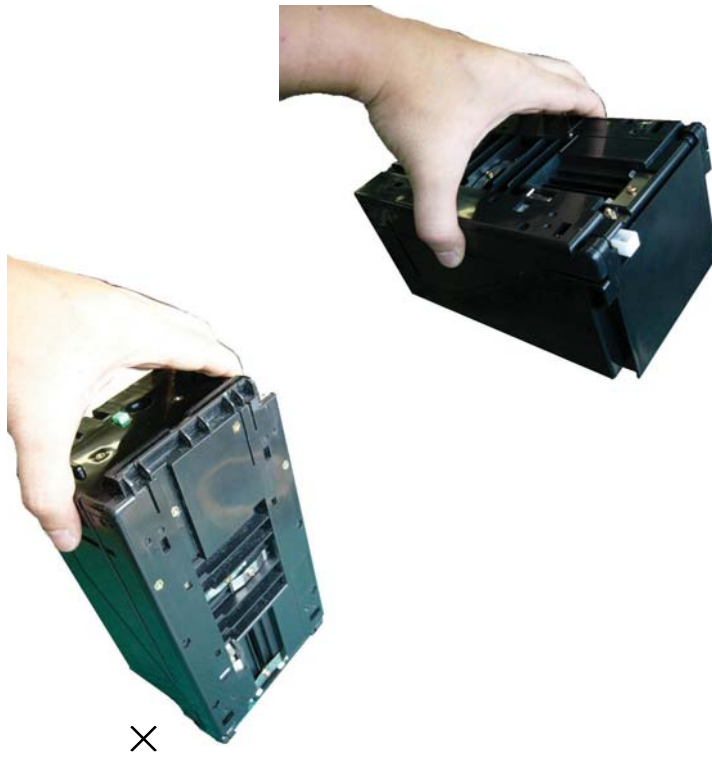

2.1.6 Notes on loading bills

Before loading bills, follow the instructions below for proper operation.

- (1) Fan the stack of bills before loading.

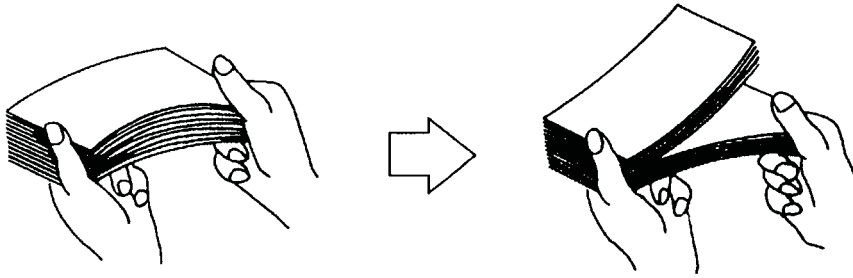

- (2) Align bills before loading them.

Don't allow any bill protruding from the bunch.

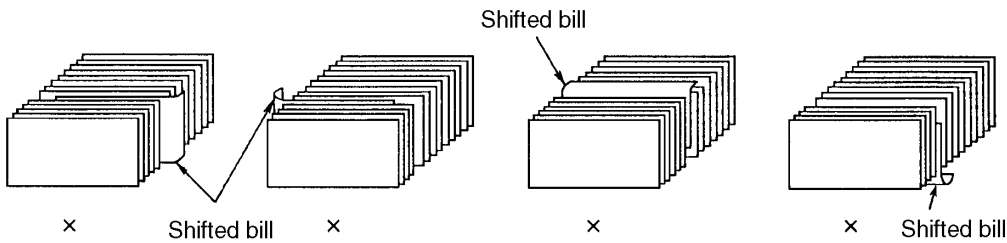

- (3) Load bills in staggered units of 100 sheets so that the stack of bills does not bulge.

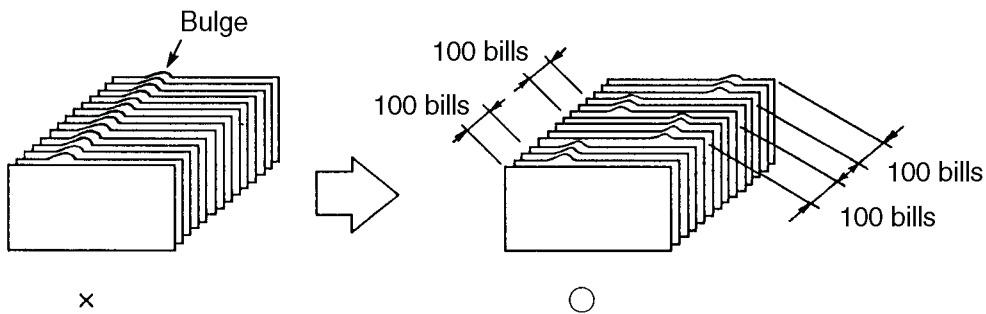

- (4) Straighten any folded corners of bills as much as possible before loading.

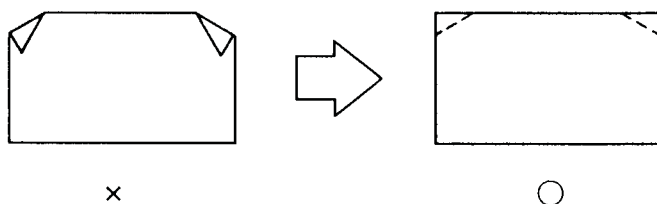

(5) Do not use bills repaired with tape.

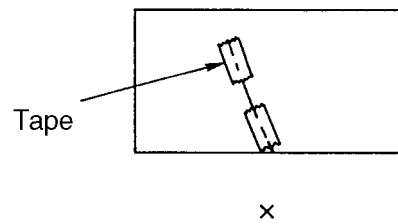

(6) When loading a bill bunch into a cassette, make sure that the bottommost bill gets no twist or fold.

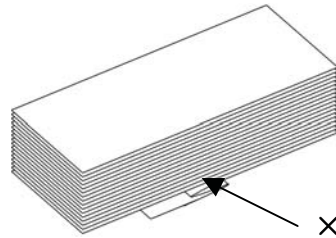

(7) Please smooth the bended or crushed bills out.

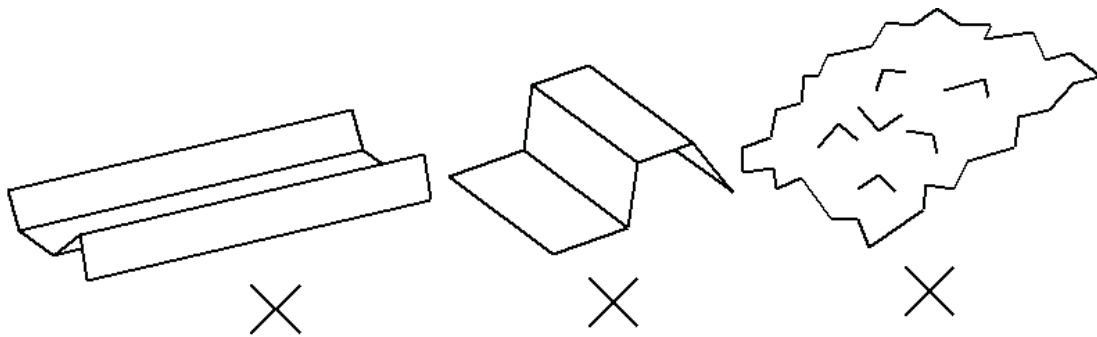

(8) Do not use the bills having serious wrinkles or broken section wherein paper fiber is broken and separation begin. Broken section

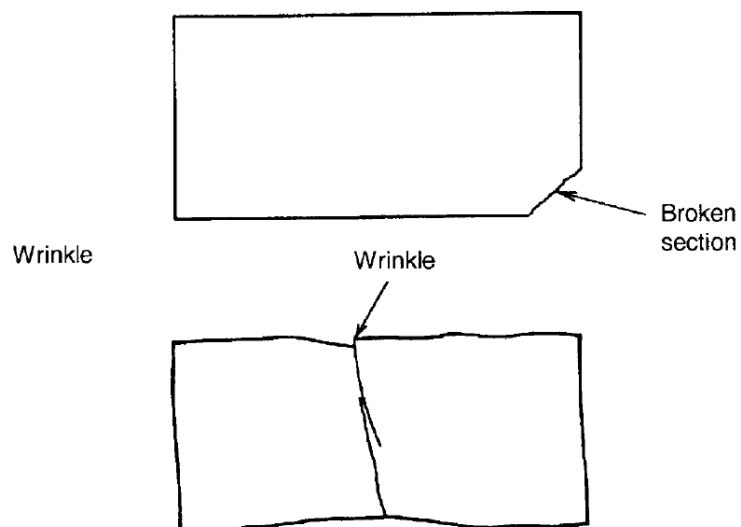

(9) Do not use the bills having adequate life or sizing, but stained seriously.

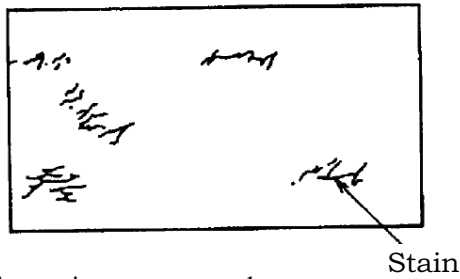

(10) Do not use the bills having serious worn out place.
The bill thickness should not be less than 0.08mm

(11) Do not use the bills with holes. (Perforated bills)

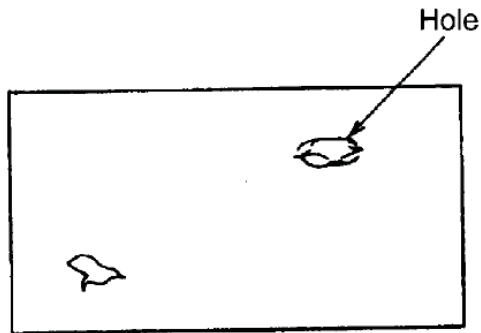

(12) Do not use the bills ragged and cannot be held straightly when one end is supported by a hand.

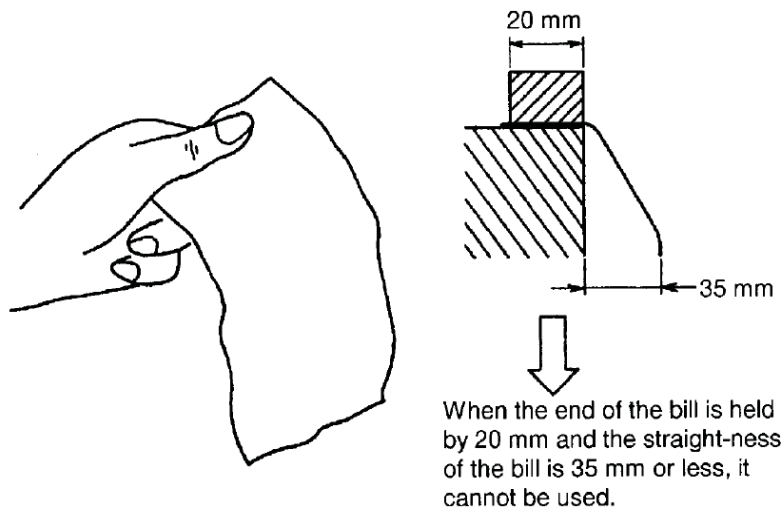

(13)
① Bill distortion should not exceed 5 mm.

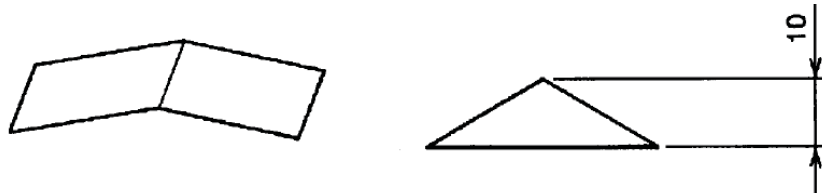

Bill distortion should not exceed 10 mm.
② Do not use.

③ Bill di



Bill distortion should not exceed 10 mm.

Bill distortion should not exceed 10 mm.

④ Bill distortion should not exceed 5 mm.

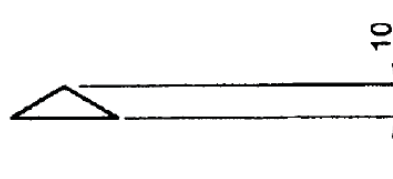

⑤ Do not use.

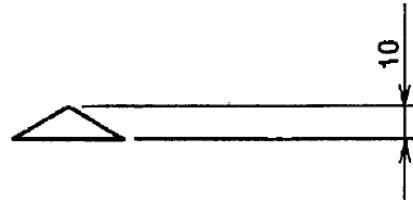
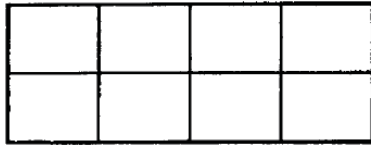

(14) Do not use the bills with curl.

① Bill distortion should not exceed 5 mm.

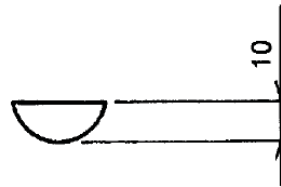
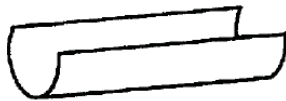

Bill distortion should not exceed 10 mm.

② Bill distortion should not exceed 5 mm.

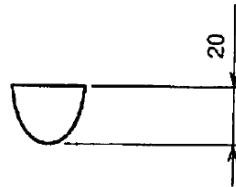

(15) Do not use the bills with stapling needle.

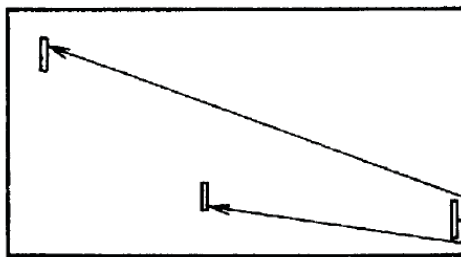

Stapling Needle

(16) Do not use the bills greatly curved. (bills tied by band seal, etc.)

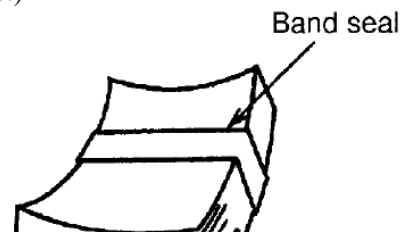
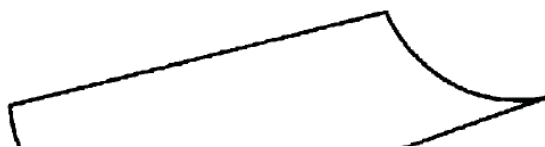

(17) I

Folding

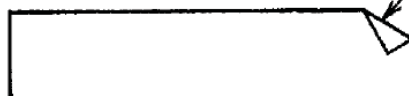

Folding



(18) Do not use the bills folded at middle portion.

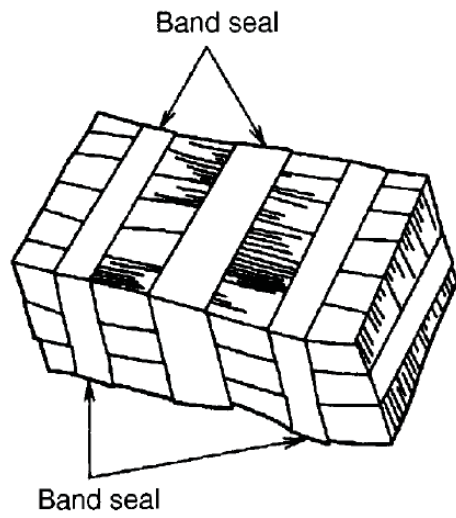
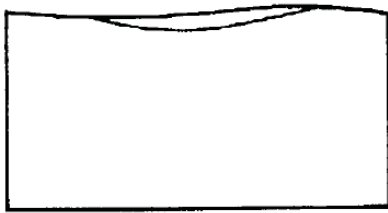

(19) Do not use the waving bills.

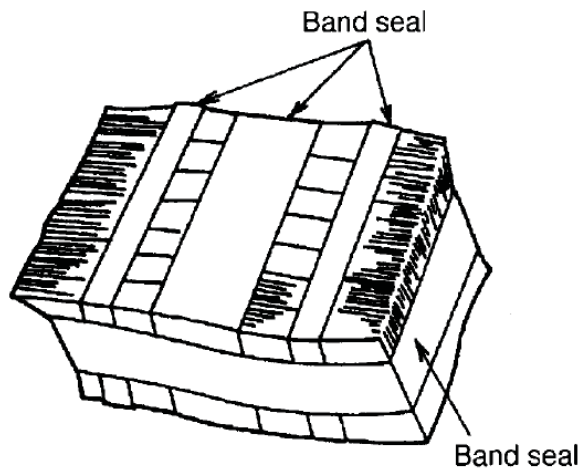
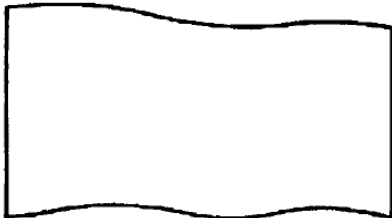

(20) Caution for new bills

Once arrange the bills as shown below, and then introduce them into the cash cassette.
Paste is used for new bills packing.

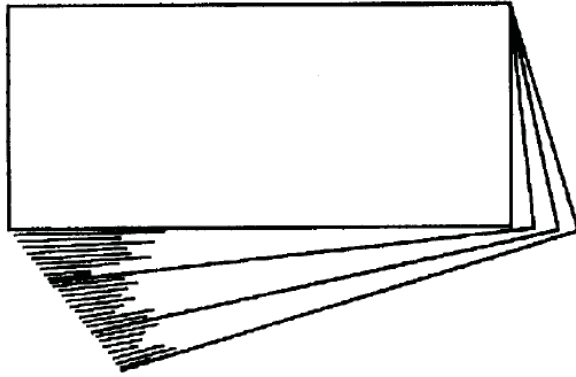

Without removing paste, bills pick failure will occur.

(21) Mounting conditions of deformed bill.

A maximum of 10 identically deformed bills can be mounted at once.
To mount more than 10 bills at once will cause pitch failure or jamming.

| | | | |
|-------------------------|------------|---|----------------|
| Notice : Environment | | | |
| Environment temperature | Operating | : | 0 to 45 deg C |
| | In storage | : | -5 to 50 deg C |
| Environment Humidity | Operating | : | 10 - 95%RH |
| | In storage | : | 8 - 95%RH |



Standard Change-Makers, Inc.

3130 N. Mitthoeffer Road

Indianapolis, IN 46235

Toll Free: 1-800-968-6955

Phone: 317-899-6966

Fax: 317-899-6977

Web Site: www.standardchange.com

FOR SERVICE OR TECHNICAL SUPPORT:

Call: 1-800-968-6955

E-Mail: service@standardchange.com

SALES REPRESENTATIVES:

Eastern U.S.: Dan Wagner

PH: 610.942.4215 EM: dwagner@standardchange.com

East-Central U.S.: Mike Enz

PH: 937.679.6090 EM: menz@standardchange.com

West-Central U.S.: Dale Hughson

PH: 319.239.2481 EM: dhughson@standardchange.com

Western U.S.: Mike Coons & Barb McColly

PH: 800.968.6955 x111 EM: mcoons@standardchange.com

PH: 800.968.6955 x110 EM: bmccolly@standardchange.com

Canada: Paul Thompson

PH: 514.502.0124 EM: sales@standardchange.ca