

Thank you for purchasing the **SC-CONVERSION** System 500/600 Conversion Kit. This Kit is available in two different versions:

**Part # 4K01328-FI – SC-CONVERSION Conversion Kit with MEI (Mars) Bill Acceptor**

**Part # 4K01327-FI – SC-CONVERSION Conversion Kit with Coinco Vantage Bill Acceptor**

The basic parts of the kits are the same. The Bill Acceptor included is dependent on which part number you ordered. Please check to be sure that you received the proper bill acceptor before proceeding.

## INTRODUCTION

The SC-CONVERSION KIT allows you to modify your existing Standard Change-Makers SC Series change machine that currently has one of the following bill acceptors installed:

- ▶ System 500 (Black cover plate) *circa 1987-1993*
- ▶ System 500-E (Blue cover plate) *circa 1993-1998*
- ▶ System 600-FST (Red cover plate) *circa 1998-2006*
- ▶ System 600-EF (White/US flag cover plate) *circa 2006 - 2012*

The SC-CONVERSION Conversion Kit works well with two bill acceptors compatible with the MDB interface: Mars (MEI) AE2600 series or Coinco Vantage series. The bill acceptor must be configured for the down-stacking option when used in the conversion kit. The SC-Conversion Kit comes supplied with your choice of these two bill acceptors.

The **SC-CONVERSION Controller** controls the entire machine and interfaces between the coin hopper(s) and the bill acceptor. You can dispense any type of coins, including tokens - providing that you have the proper hopper mechanism configuration for the diameter and thickness of the coin/token.

The installation process does not require a strong technical background and only a few basic tools are required. You should allow approximately 30-60 minutes to perform the conversion kit installation. Your subsequent installations will take less time.

The SC-CONVERSION KIT offers all the same functions that were available in the original Standard bill acceptor, including, a full detailed audit available on the SC-Conversion Controller display or printed via the Portable Audit Printer Kit (optional).

## TOOLS REQUIRED:

- 11/32" Nut Driver or Socket
- 3/8" Nut Driver or Socket
- 7/16" Nut Driver or Socket
- Phillips #2 Screwdriver
- Needle Nose Pliers

**If you have any questions prior to or during the installation of this kit, please contact our SERVICE DEPARTMENT at Standard Change-Makers, Inc. – by calling 1-800-968-6955 – Monday through Friday: 8:30 AM – 5:30 PM (Eastern Time)**

To begin the conversion, we should check to be sure you have everything needed in your Conversion Kit...

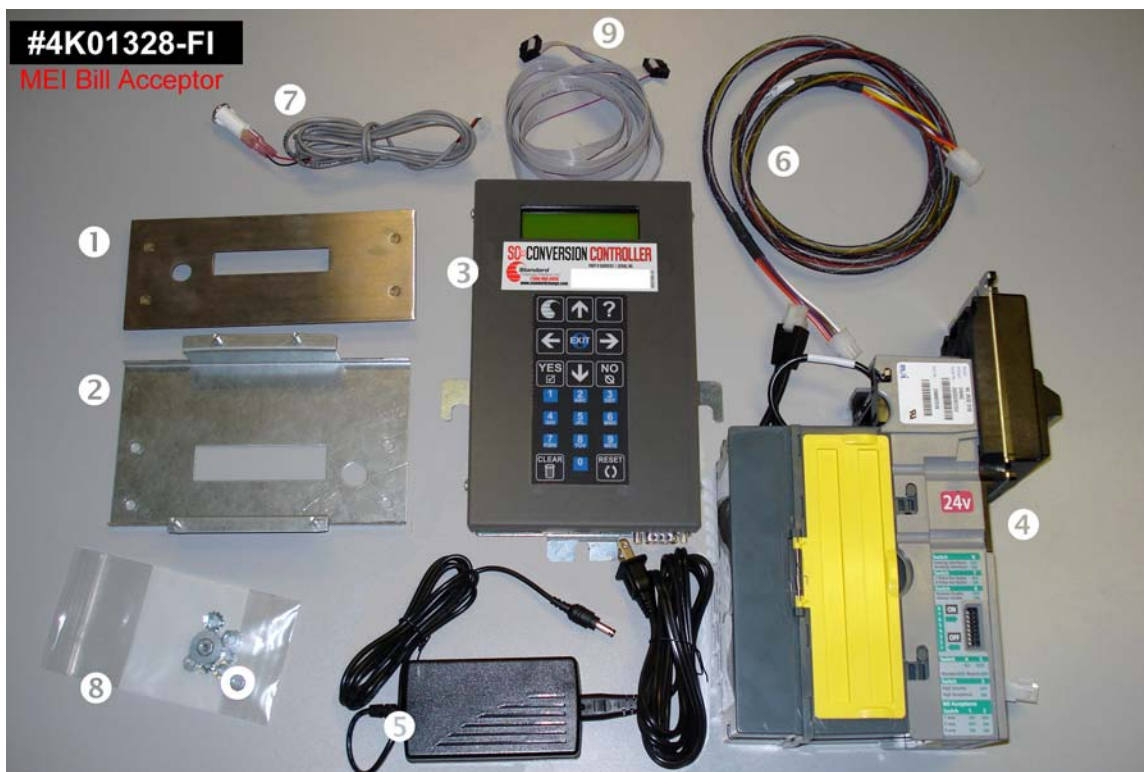

The **SC-CONVERSION KIT** consists of the following components (Please check to be sure you have all these components prior to starting the conversion of your change machine):

- (#1) External Stainless Steel Cover Plate/Bezel (Part #2F04830)
- (#2) Internal Bill Acceptor Mounting Bracket (Part #2F06138)
- (#3) SC-CONVERSION Controller - with green LCD display & touch buttons (Part #5A00221)
- (#4) MEI #VN2632-D7M-US MDB Bill Acceptor (Part #5V00226)
- or -
- (#4) Coinco #VX63D45US00 Bill Acceptor (Part #5V00352)
- (#5) 24V DC (New) Power Supply (Part #5P00117)
- (#6) MDB Bill Acceptor cable (Part #4C00263)
- (#7) 28V “Out of Service” Indicator Lamp harness (Part #4C00300)
- (#8) Installation Hardware - plastic bag with assorted nuts, washers, and tie-wraps
- (#9) Flat cable for connection to MEI Cashflow 330 Coin Acceptor (if necessary) (Part #4C00196)
- (Not Shown) Bill Insertion Decals for Cover Plate
- (Not Shown) Installation Instruction Sheet (Part #8M00619)

### **STEP 1 - REMOVING COMPONENTS:**

**NOTE:** Take the audit reading before removing the bill acceptor. Otherwise it will be too late.

1. Shut main power OFF by unplugging machine from the wall outlet, or turning power off at the electrical panel (hard wired).
2. Disconnect all wires and cables from the System 500/500-E/600-FST/600-EF bill acceptor. Be sure to keep the Power Cable (GREEN wrap on ends – connects to 40-watt Power Supply), as you will re-use this cable with the Conversion Kit.

3. Pull the stacker down by pressing the lever under the stacker box. Disconnect the cables from the stacker and remove the stacker from its mounting brackets.
4. Remove the bill acceptor. To remove, simply pull the black plastic clamps out and pull the unit up and back from the mounting bracket.
5. Remove the front black bezel held in place with (4) big slot screws. (See Fig. B)
6. Remove the internal bracket held in place with four 7/16" nuts. (See Fig. B)
7. Remove the keypad and its bracket. (Recommended: Keep the communication wire as a spare for future use.)
8. You may also choose to remove the Stacker Mounting Brackets. To do so, simply remove the 7/16" nuts.

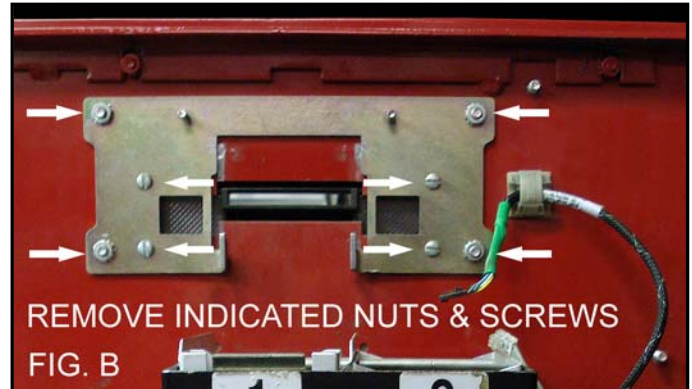

### NOTE: REPLACING THE LEXAN™ DECAL:

If you decide to change the Lexan™ decal of the machine, you will have to remove the coin bezel and the lock cylinders as well. Remove the old decal or vinyl while making sure there is no residue of glue remaining. Apply a new decal carefully. Make the necessary cuts. Re-install the lock cylinders and the coin bezel.

### STEP 2 – INSTALLING CONVERSION COMPONENTS:

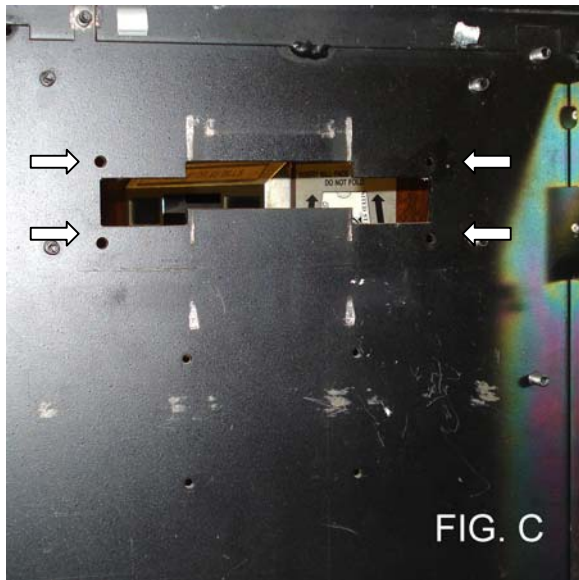

**FIG C – Shows the old SC Series Bill Acceptor Assembly and Mounting Bracket removed from the cabinet, and the 4 holes where the External Cover Plate studs will fit through**

**FIG D – Shows the Stainless Steel External Mounting Plate installed & OOS Indicator Lamp wires inserted in opening**

1. Take out all the SC-CONVERSION KIT components from the box.
2. Locate the External Cover Plate (#1). Install this plate on the outside the machine door (front loads) or on the stainless steel faceplate (rear loads), by placing the studs through the four existing holes from removal of the SC Series acceptor removal (See FIG. C).



3. Locate the small 28-volt “Out of Service” Indicator Lamp and harness (#7). Pass it by the round hole of the Stainless Steel Exterior Cover Plate (See FIG. D)
4. Install the MEI or Coinco Bill Acceptor (#4), using the 11/32” nuts to the steel Internal Mounting Bracket (#2) (See FIG E).

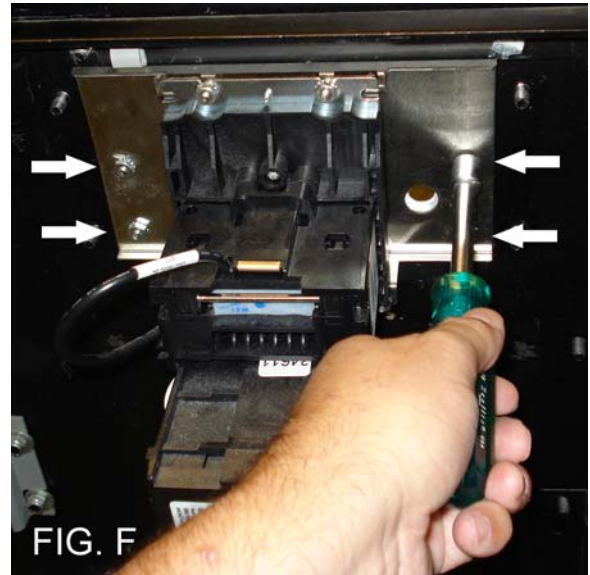
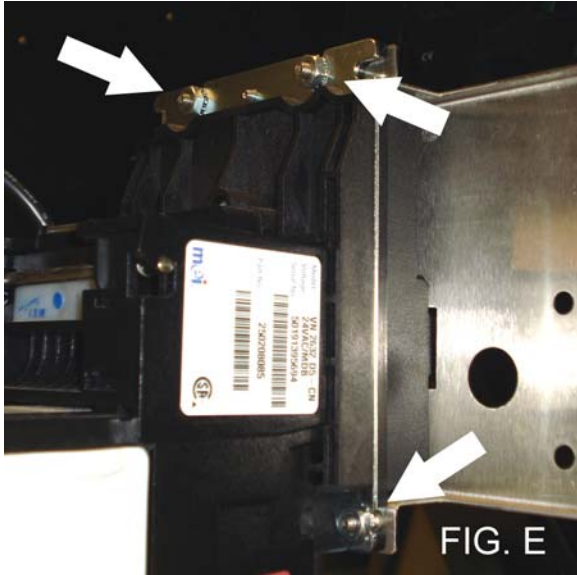

**FIG. E – Attach the Bill Acceptor to the Internal Mounting Plate using (4) 11/32” nuts (arrows show 3 of 4 locations)**

**FIG F – Attach completed Bill Acceptor & Mounting Bracket assembly to the studs from the External Cover Plate**

5. Affix the Internal Mounting Bracket & Bill Acceptor Assembly in place, matching up the threaded studs with the holes in the Internal Mounting Bracket (See FIG F).
6. Tight both plates together with the 3/8” nuts (included).
7. Place the **SC-CONVERSION CONTROLLER** (#3) where the keypad and its support were, using the nuts and washers (See FIG G).
8. Pass the cables making sure you do not damage them with the continuous opening of the door or the hopper tilting or any other moving parts. The cables are: (1) MDB Bill Acceptor Communication cable, (2) “Out of Service” Indicator Lamp and (3) Flat Coin Acceptor Ribbon cable (only if you have a Coin Acceptor installed in your machine – See Instructions below).
9. Connect all the cables to the SC-CONVERSION CONTROLLER (#3) into the indicated locations on the SC-CONVERSION CONTROLLER labels, including the original Power Supply cable (green ends) with flat black connector that is also plugged into the 40-watt power supply.



**FIG. G**

(See FIG H on Page 5).

10. The new 24VDC Power Supply (#5) connects directly into the 120-volt outlet in the machine. IMPORTANT NOTE: If you do not have a separate AC outlet in your machine, you will have to install one.
11. Connect all the Hopper Communication Cables (up to 4), in the appropriate location on the underside of the SC-CONVERSION CONTROLLER. Be certain that you follow the Hopper Location Label (A, B, C, D) as shown on the hopper labels. Hopper A plugs into the DISP A location on the Controller, etc.

FIG. H

# SC Conversion Kit Connections Chart

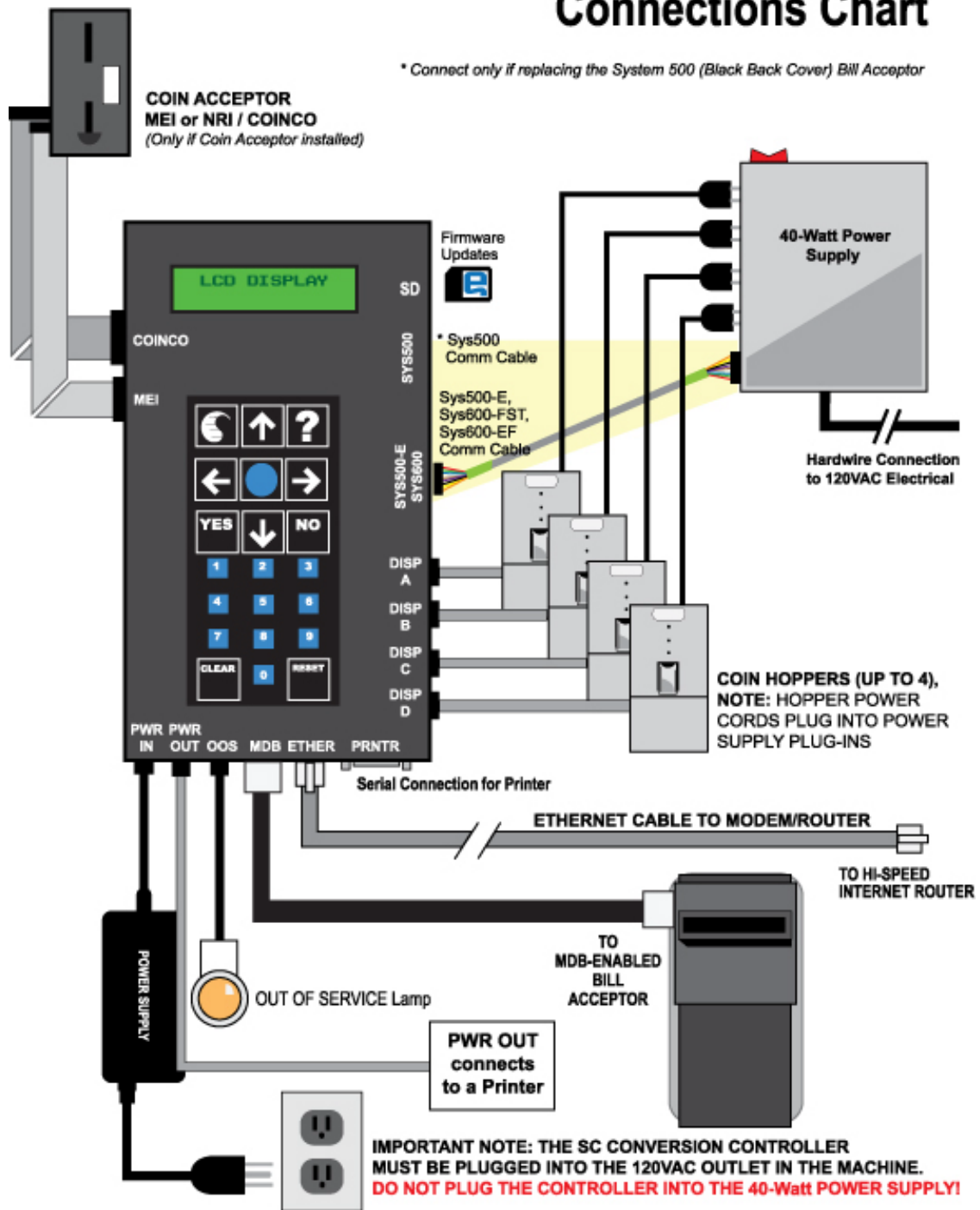

\*\*\* If your Change Machine does not have a Coin Acceptor – Proceed to Step 3. \*\*\*

FOR MACHINES EQUIPPED WITH MEI CASHFLOW COIN ACCEPTOR:

**NOTE:** The System 500-E through System 600-EF have used the Mars (MEI) Cashflow 330 Electronic Coin Acceptor for many years. If you have a different model, please contact our Service Dept (1-800-968-6955) about any other model of coin acceptor.

1. Remove the Coin Panel from its mounting bracket.



2. On the backside of the Coin Panel you will see two Flat Ribbon Cables (**See FIG J**). One is connected to the 10-PIN connector at the bottom, and the other was connected to the SC Series Bill Acceptor. The other end of this cable is connected to a board in the Coin Panel. Unplug the 10-PIN connection from the back. You will not use this cable with the SC-CONVERSION Conversion Kit.
3. Using the supplied Flat Ribbon Cable (#9), connect one end to the same 10-PIN connector and the other end will be connected to the 10-PIN Connection on the SC-CONVERSION Controller (#3)
4. Using a rubber band or one of the supplied wire ties, secure the Flat Ribbon Cable with other cables being sure not to crimp or twist, and leaving enough slack to allow the door to open completely.
5. Replace the Coin Panel back into its Mounting Bracket.

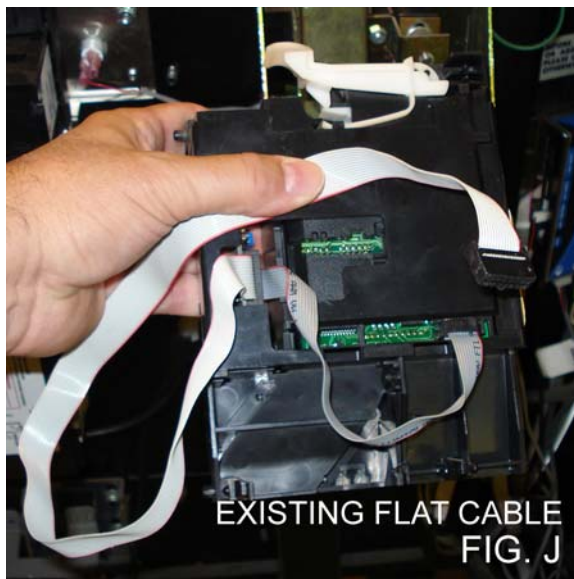

Once all components have been installed and cables connected, you are ready to proceed to Step 3.

### STEP 3 – PROGRAMMING THE CHANGE MACHINE:

#### **PROGRAMMING THE COINCO VANTAGE BILL ACCEPTOR:**

If you are using a Coinco bill acceptor, it should ship from the factory with default settings similar to the Mars unit describe above. If you would prefer to change any of these default settings - consult the Quick Reference Guide included with the bill acceptor.

After you have installed the SC-CONVERSION CONTROLLER connections, and programmed your bill acceptor, you are ready to power up your change machine.

#### **PROGRAMMING THE MEI (MARS BILL ACCEPTOR):**

Programming which bills to accept is done directly on the MEI bill acceptor. On one of the side of the bill acceptor is a green and white sticker surrounding the programming dipswitches.

The Mars (MEI) Bill Acceptor switch settings are as follows:

- 1-2 Ways of Bill insertion (1, 2 or 4 way) (ON-ON)
- 3 High security (OFF) or more permissive acceptance (ON)
- 4 \$10 bills accepted (OFF) or rejected (ON)
- 5 \$20 bills accepted (OFF) or rejected (ON)
- 6 The enable signal is managed by the SC-CONVERSION

(OFF).

- 7 Pulse per dollar (OFF)
- 8 Vending Interface (ON)

**Follow the Chart provided in FIG. L (right)**

**BEFORE APPLYING POWER TO YOUR MACHINE, PLEASE READ THIS:** The original Power Supply, also referred to as the 40-Watt Power Board, now only serves to provide power for the coin hoppers only. It does not provide power to the SC-Conversion Kit. In order for your machine to operate properly, the main switch must be turned on AND the new power supply must be plugged into the other AC outlet. This means, when you power down the machine, you must unplug the new power supply and turn off the main switch as well.

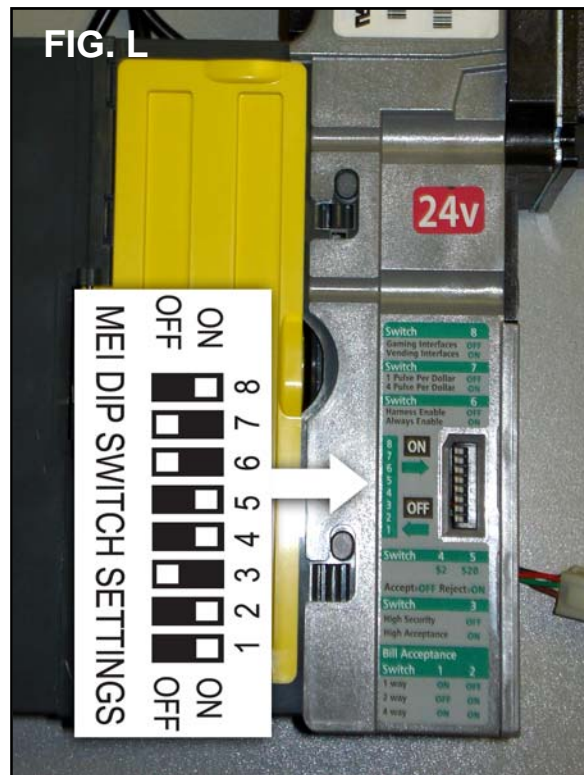

### STEP 4 – POWERING UP YOUR MACHINE:

**Apply POWER to your change machine by flipping the breaker or turning on the main power switch, and plugging in the new Power Supply into the 120 VAC outlet.**



---

After you apply power to the machine, you will experience a 3-5 second delay before you hear the bill acceptor motor activate and the indicator lights activate. The LCD display on the SC-CONVERSION CONTROLLER will turn on, then the display will show the words “**OUT OF SERVICE**” to indicate it is ready.

At this point, you should put some coins in the hopper(s) and insert individual bills and coins and check the amount dispensed for proper change.

### **EXCEPTIONS ON THE CABINET DESIGNS:**

#### **SC90 AND SC100 SERIES MACHINES REQUIRE CABINET MODIFICATION**

The SC90 (SC93, SC94, SC93-TOK, SC94-TOK, etc.) and SC100 (SC101 & SC102) Series changer require a small cabinet modification when installing the SC-CONVERSION KIT.

In order to install the down-stacking MEI or Coinco bill acceptor in these machine models, you must cut the lip of the cabinet – where the door meets the frame of the opening – because the bill acceptor is mounted higher on the door, and there is insufficient clearance for the new bill acceptor models.

The modification requires you to install the External Cover Plate and Internal Mounting Bracket with the Bill Acceptor attached. Closing the door carefully – mark the area where the top of the bill acceptor meets the door frame. Using a metal saw or a high-speed rotary tool (such as a *Dremel*), make two vertical cuts in the lip of the cabinet. Once the cuts are finished, use a good pair of pliers pry the lip back into the cabinet to provide the needed clearance (See **FIG M**).

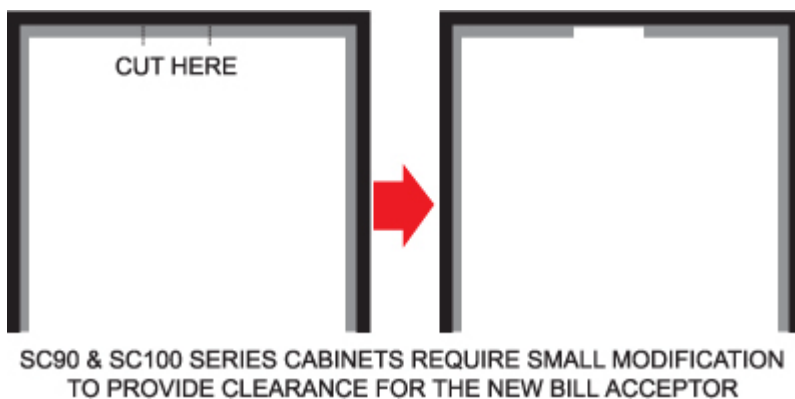

**FIG. M**

**Congratulations!** You have completed the installation of your SC-CONVERSION Conversion Kit. If you have any problems with the operation of the machine during the testing phase, please re-read the instructions to be sure that all installation operations have been completed properly. Check to be sure that your cables are installed in the proper places and connected properly. If all of this checks out, please contact the Standard Change-Makers, Inc. Service Dept. at 1-800-968-6955.



**SC CONVERSION CONTROLLER CONNECTIONS**

SC Conversion Controller - BOTTOM SIDE

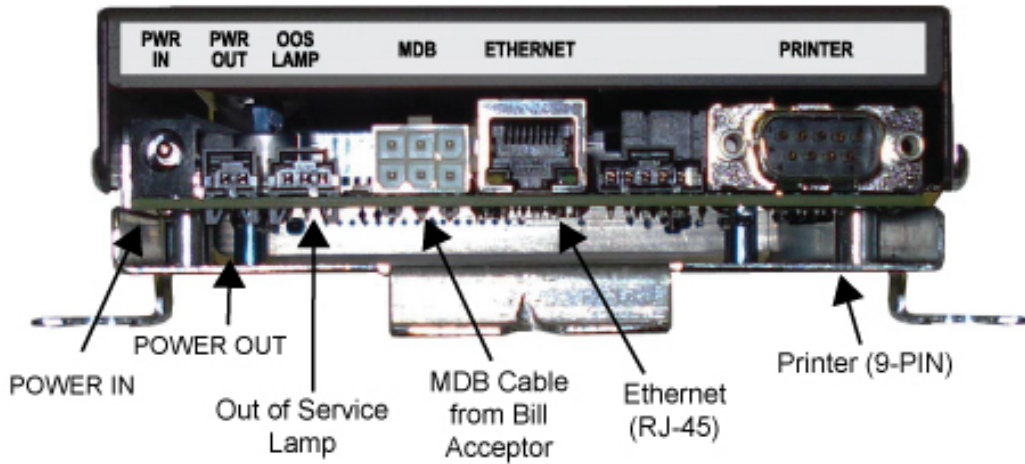

SC Conversion Controller - LEFT SIDE

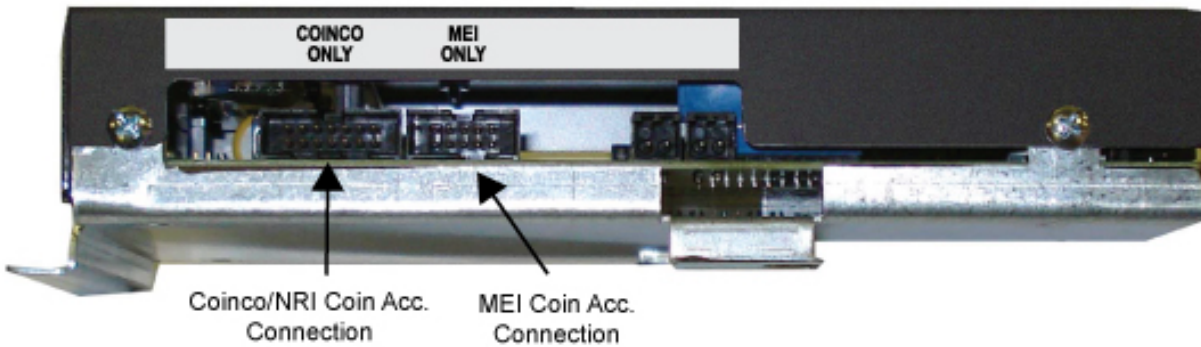

SC Conversion Controller - RIGHT SIDE

